

Medical Electrochemical Galvanic Fuel Cell Percent Oxygen Sensor



Specification:

Sensor Technology	Electrochemical
Signal Output ¹	45 - 64 mV
Measuring Range	0 - 100 Percent
Response Time T90	8 Seconds
Accuracy Full Scale ²	± 1% of Signal
Repeatability F.S.	± 0.5%
Temperature:	Compensated
Operating Temp	0 to 45 °C
Storage Temp	0 to 45 °C
Cross Sensitivity:	ISO 80601-2-55
Housing Material:	White ABS
Humidity	0 - 100% RH (Non - Condensing)
Expected Life ³	< 60 Months
Warranty ⁴	16 Months

1. Signal output is measured in air at 25 °C, sea level.
2. Full Scale accuracy is calculated with constant pressure, temperature and proper calibration (80% O₂ value on full scale range). Drastic temperature change can result in a maximum error of ± 10%.
3. Expected life is calculated when O₂ < 20.9% @ 25 °C, sea level.
4. Southland Sensing Ltd. warrants the sensors for the period noted above to be free from defects in materials and workmanship. Southland Sensing Ltd. will not be held liable for sensors damaged due to customer neglect.

Intended Use:

These oxygen sensors, with their excellent stability, performance and linearity are designed to be used to monitor the partial pressure of oxygen in breathing gas mixtures for anaesthesia, ventilators, medical oxygen concentrators, incubators, and general oxygen monitors.

Dimensions:

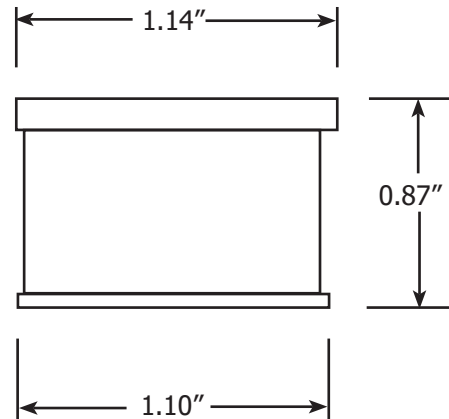

Pinout Diagram:

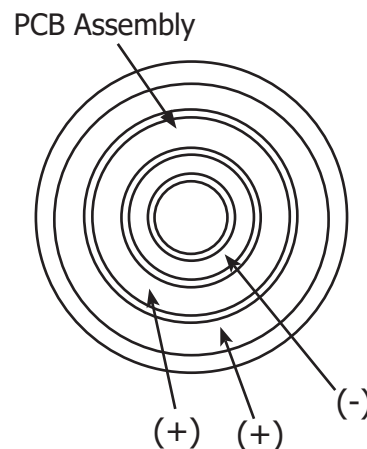

FDA510K Coming Soon