

H2S-625 Hydrogen Sulfide Analyzer

ATEX and IECEx Certified for Hazardous Areas



Part 1 Introduction

- 1.1 General Introduction
- 1.2 Principle of Operation - The Hydrogen Sulfide Sensor
- 1.3 H2S-625 Specifications
- 1.4.1 General Safety Information (VAC)
- 1.4.2 General Safety Information (VDC)
- 1.5 Location Installation Considerations
- 1.6 Safety Considerations

Part 2 Installation

- 2.1 Receiving Your New Hydrogen Sulfide Analyzer
- 2.2 Mounting The Hydrogen Sulfide Analyzer
- 2.3.1 Electrical Connections (VAC)
- 2.3.2 Electrical Connections (VDC)
- 2.3.3 Earth Grounding The Analyzer
- 2.4 Gas Connections
- 2.5 Installing The Hydrogen Sulfide Sensor
- 2.6 Integral Sample System Flow Diagram
- 2.7 Sensor Selection

Part 3 Operation

- 3.1 Understanding The Controls and Their Operation
- 3.2 Manual Range Output Adjustment
- 3.3 Analog Output 4 - 20mA or 1 - 5 VDC
- 3.4 Advanced Integral Alarms
- 3.5 Setting a Custom Range
- 3.6 Output Simulation
- 3.7 Output Calibration

Part 4 Maintenance

- 4.1 Span Calibration Using Certified Span Gas
- 4.2 Procedure for Replacing the Sensor
- 4.3 Troubleshooting

Part 5 Annexures

- 5.1 Spare Parts List
- 5.2 Warranty
- 5.3 Material Safety Data Sheets
- 5.4 Conformance Certificate
- 5.5 Modbus Instructions
- 5.6 Explosion Proof Electrical Connections

1.1 General Introduction

The Southland Sensing H2S-625 Hydrogen Sulfide Analyzer is a microprocessor based online unit designed for continuous measurements in a variety of hazardous area applications and gas mixtures. The Analyzer is certified for use in Zone 1 Group IIB+H2 (ATEX, IECEx and UKEX).

The analyzer was designed with the customer in mind, keeping the operations simple while still featuring a fast response and rugged design. Every effort has been made to use modern industrial components and materials which has resulted in an advanced design, excellent performance, and an overall low cost of ownership.

The analyzer has numerous options including VAC or VDC power input with an isolated analog 4 - 20mA or 1-5 VDC concentration output and optional digital RS485 Modbus RTU output meeting most hydrogen sulfide analysis applications.

Southland Sensing Ltd. appreciates your business and recommends reading through the complete manual to be able to get the full experience from your new hydrogen sulfide analyzer.

1.2 Principle of Operation - The Hydrogen Sulfide Sensor

The precision electrochemical hydrogen sulfide sensor used in the H2S-625 is designed and manufactured under a strict quality procedure.

To understand how the hydrogen sulfide analyzer functions, it is important to understand a little bit of the sensor characteristics.

The active components in the precision electrochemical hydrogen sulfide sensor are the anode, cathode, and aqueous electrolyte which are all housed in the cell body. The hydrogen sulfide molecules in the application pass through the front sensing membrane into the electrolyte, where a chemical reaction occurs and a raw electrical current is generated.

These analyzers need to be calibrated using a span gas with a known H2S value. It's important to calibrate with the same flow rate as your process gas, we recommend a flow between 0.5 - 1.5 SCFH.

This electrical current is proportional to the amount of hydrogen sulfide in the application. The analyzer then processes this raw electronic signal, compensates for temperature, barometric pressure, and flow variations, and converts the data into a parts-per-million hydrogen sulfide measurement value.

The hydrogen sulfide concentration reading is then displayed in real time on the full backlit display and the user can automate the control of their process using any of the output signals which can be run to

Hazardous Area Online Process Hydrogen Sulfide Analyzer w/ Sample System
ATEX and IECEx Certified for Hazardous Areas



Optional Configurations:

- Sample System Add-On Components
- Bi-Directional RS485 Modbus RTU
- Extreme Weather Packaging
- Extended Temperature Ranges

Applications:

- Natural Gas Extraction & Pipelines
- Natural Gas Processing
- Landfill Gas Monitoring
- Biogas before and after the H2S Scrubber
- And Many Other Industrial Applications

"Inquiry for Application Expertise"

Precision Electrochemical H2S Sensor

Designed for Natural gas & Biogas Applications

F.S. Ranges of 0 - 10 ppm up to 0 - 10000 ppm

Cost Effective and Low Maintenance

Large Backlit Display

Intuitive User Friendly Interface

Optional MODBUS RS485 RTU

2 Fully Configurable Alarm Relay Contacts

Specifications:

| | |
|-----------------------|----------------------------------|
| Accuracy: | < +/-1% Full Scale Range* |
| Alarms: | 2 Configurable Relay Contacts |
| Analyzer Range: | Multiple up to 0 - 10000 ppm |
| Area Classification: | Zone 1 IIB + H2 |
| Dimensions: | 12" x 12" x 5.25" |
| Flow: | 0.50 - 5.0 SCFH |
| Gas Connections: | 1/4" Compression Tube |
| Output: | Isolated 4 - 20mA or 1 - 5 VDC |
| Power: | 12 - 24 VDC 100 - 240 VAC |
| Pressure | 0.1 - 50 PSIG Inlet, vent to atm |
| Response Time: | T90 in 45 Seconds |
| Sample System: | Optional |
| Sensor: | Precision Electrochemical Cell |
| Temperature: | 0 to 50 deg C |
| Warranty Sensor: | 12 Months |
| Warranty Electronics: | 12 Months |
| Weight: | 21 lbs |

*Accuracy at constant conditions

Cross Sensitivity

Sensor response per 100 ppm of gas present:

| | |
|-------------------|--------|
| Methyl Mercaptan: | 40 ppm |
| Carbon Monoxide: | 4 ppm |
| Hydrogen: | 1 ppm |
| Sulfur Dioxide: | 18 ppm |

H2S Analyzer:

The model H2S-625 Hydrogen Sulfide analyzer combines a rugged design with SSO2's precision H2S sensors. The result is a highly reliable and cost effective compact design with an easy-to-use user interface designed specifically for the Natural Gas and biogas industries.

The oxygen analyzer is certified for use in Zone 1 IIB + H2 applications.

The H2S analyzer is isolated both on the power input and analog output. This eliminates most electronic gremlins seen with existing competitive equipment in the field.

Gas connections are made with 1/4" Compression tube fittings. Sample Systems includes Sample / Span valve and flow meter.

The H2S-625 analyzer comes with an optional MODBUS RS485 RTU Bi-Directional Communication protocol.

H2S Sensor Technology:

The H2S sensor used in the H2S-625 is based on the galvanic electrochemical fuel cell principal. All H2S sensors are manufactured under a strict quality program.

The sensors are self-contained and minimal maintenance is required - no need to clean electrodes or add electrolyte.

The Southland Sensing precision H2S sensors offer excellent performance, accuracy and stability while maximizing the expected life.

Power Requirements:

Input Power: 12 - 24 V DC
Current Draw: 50 mA
** Optional power input choices available

H2S Sensors:

H2S-1x PPM H2S Sensor: 0 - 200 Max PPM Range
H2S-2x PPM H2S Sensor: 0 - 2000 Max PPM Range
H2S-3x PPM H2S Sensor: 0 - 10000 MAX PPM Range

H2S sensors should be periodically calibrated. Factory recommendation is every 1 - 3 months or as the application dictates. Sensors offer excellent linearity when calibrated to a certified span gas.

Order Information:

Record Part Number with selected options in Blank Indicated Area of Form

Model Number:

H2S-625 H2S Analyzer

Selected Range & Sensor:

- 1 0 - 200 PPM; H2S-1x PPM H2S Sensor (Ranges: 0 - 10 ppm, 0 - 50 ppm, 0 - 100 ppm, 0 - 200 ppm)
- 2 0 - 2000 PPM; H2S-2x PPM H2S Sensor (Ranges: 0 - 100 ppm, 0 500 ppm, 0 - 1000 ppm, 0 - 2000 ppm)
- 3 0 - 10000 PPM; H2S-3x PPM H2S Sensor (Ranges: 0 - 1000 ppm, 0 - 2000 ppm, 0 - 5000 ppm, 0 - 10000 ppm)

Electronics Package:

- 4 12 - 24V DC Input Power
- 4M 12 - 24V DC Input Power + MODBUS RS485 RTU
- 7 100 - 240 VAC Input Power
- 7M 100 - 240 VAC Power + MODBUS RS485 RTU

Gas Connections:

- 4 1/4" Compression Tube Fittings with Sample / Span Valve & Flowmeter
- 6 6 mm Compression Tube Fittings with Sample / Span Valve & Flowmeter
- D Delete Sample / Span Valve & Flow Meter, 1/8" Compression Tube Fittings

H2S-625 - _____ - _____ - _____ Use This Part Number When Ordering

ATEX:

Southland Sensing Ltd.
4045 E. Guasti Rd. Suite 203, Ontario, CA 91761 USA
H2S-625 Series Hydrogen Sulfide (H2S) Analyzer

ExVeritas 23ATEX1653X

 II 2 G

Ex db ib IIB+H2 T4 Gb

Tamb -20°C to +50°C



IECEx:

Southland Sensing Ltd.
4045 E. Guasti Rd. Suite 203, Ontario, CA 91761 USA
H2S-625 Series Hydrogen Sulfide (H2S) Analyzer

IECEx EXV 23.0038X

 II 2 G

Ex db ib IIB+H2 T4 Gb

Tamb -20°C to +50°C



1.4.1 General Safety & Installation (VAC)

This section is for AC powered analyzers, if your analyzer is DC powered proceed to the next page.

This section summarizes the precautions applicable to the H2S-625 Hydrogen Sulfide Analyzer. Additional precautions specific to this analyzer are contained in the following sections of the manual. To operate the analyzer safely and to obtain the best performance, follow the basic guidelines outlines in this owner's manual.



CAUTION: This symbol is used throughout the owner's manual to caution and alert the user that this device is operated on AC Voltage (VAC)



CAUTION: This symbol is used throughout the owner's manual to caution and alert the user to recommended safety and / or operating guidelines.



WARNING: This symbol is used throughout the owner's manual to warn and alert the user of the presence of electrostatic discharge.

READ INSTRUCTIONS: Before operating the hydrogen sulfide analyzer, read the instructions.

RETAIN INSTRUCTIONS: The safety precautions and operating instructions found in the owner's manual should be retained for future reference.

FOLLOW INSTRUCTIONS: Observe all precautions and operating instructions. Failure to do so may result in personal injury or damage to the transmitter.

H2S ANALYZER LABEL:

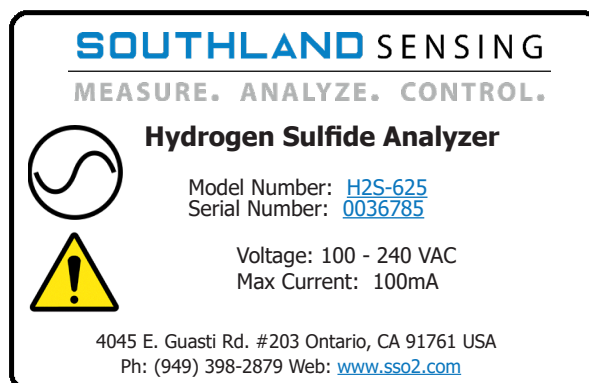

Please refer to Appendix 5.6 for making electrical connections that maintains the desired level of protection.

1.4.2 General Safety & Installation (VDC)

This section is for DC powered analyzers, if your analyzer is AC powered see the previous page.

This section summarizes the precautions applicable to the H2S-625 Hydrogen Sulfide Analyzer. Additional precautions specific to this analyzer are contained in the following sections of the manual. To operate the analyzer safely and to obtain the best performance, follow the basic guidelines outlines in this owner's manual.

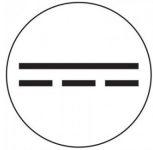

CAUTION: This symbol is used throughout the owner's manual to caution and alert the user that this device is operated on DC Voltage (VDC)



CAUTION: This symbol is used throughout the owner's manual to caution and alert the user to recommended safety and / or operating guidelines.



WARNING: This symbol is used throughout the owner's manual to warn and alert the user of the presence of electrostatic discharge.

READ INSTRUCTIONS: Before operating the hydrogen sulfide analyzer, read the instructions.

RETAIN INSTRUCTIONS: The safety precautions and operating instructions found in the owner's manual should be retained for future reference.

FOLLOW INSTRUCTIONS: Observe all precautions and operating instructions. Failure to do so may result in personal injury or damage to the transmitter.

H2S ANALYZER LABEL:

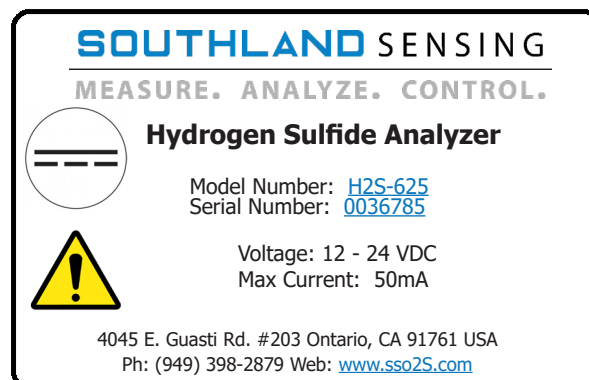

Please refer to Appendix 5.6 for making electrical connections that maintains the desired level of protection.

1.5 Location Installation Considerations

The Southland Sensing H2S-625 H2S Analyzer is designed to be mounted on a wall or on a pipe in a general purpose or Zone 1 IIB + H2 area. When installed outdoors in extreme cold areas a heavy duty heated enclosure is recommended. Consider also giving the analyzer a sun shield if it is going to be mounted in the direct sunlight.

Reference your local electrical authority for the proper installation. Reference section 5.6 for specific gland requirements.

Seals / glands are required on the power and signal conduit entries, reference your local electrical authority for the proper installation and section 5.6.

The analyzer is EMI / RFI protected, however it is good practice not to mount it too close to sources of electrical interference such as large transformers, motor start contactors, relays, large pumps, etc. Also avoid subjecting the analyzer to significant vibration.

Mount the unit at a suitable eye level to easily read the local display. Gas connections are located on the top right side of the analyzer, ensure there is adequate room to hook up your gas lines.

1.6 Safety Considerations

The hydrogen sulfide analyzer is designed for installation into either a general purpose area, or Zone 1 IIB+H2.

The analyzer consists of two enclosures mounted on a single back panel. The small Adalet enclosure on the left side is explosion-proof and contains the electrical connections for the user such as power, alarms, analog output, and digital MODBUS output (if applicable). This explosion-proof enclosure also contains the power supply and safety components for the other enclosure. The enclosure on the right contains the analytical circuitry, the oxygen sensor, and the oxygen sensor housing. This circuitry is designed for intrinsic safety and meets requirements for Zone 1 IIB + H2.

When installing a Zone 1 IIB + H2 device please follow your local electrical code should the area need to be declassified prior to installation.

2.1 Receiving Your New Hydrogen Sulfide Analyzer

As soon as you receive your new hydrogen sulfide analyzer carefully unpack the unit and accessories and inspect the interior and exterior of the analyzer for damage, and also verify the hydrogen sulfide sensor is present.

If damage to any portion of the new analyzer is present, stop and report damage to the shipping company as well as the factory.

The analyzer is shipped with all materials needed to install and prepare the system for operation. In some instances, added sample system components are necessary to condition the gas sample before entering the sensor housing. Southland Sensing offers free application consultation and we encourage you to take advantage of our engineers and their expertise.

It is also important to be mindful of EMI / RFI noise interference. Protection from EMI / RFI noise is important for accurate readings.

2.2 Mounting the Hydrogen Sulfide Analyzer

The H2S-625 is designed to be mounted on a wall or around a pipe. See below for the mounting dimensions. If mounting in extreme temperature consider an enclosure and heater if necessary.

Refer to Part 3: Operation section of this instruction manual for more information on how to operate the controls of this hydrogen sulfide analyzer.

Refer to Part 4: Maintenance section for an overview on how to calibrate the device using a certified span gas.

A precision electrochemical hydrogen sulfide sensor is included as a separate item and must be installed prior to instrument use.

H2S-625 Mounting Dimension (Sizes are in inches):

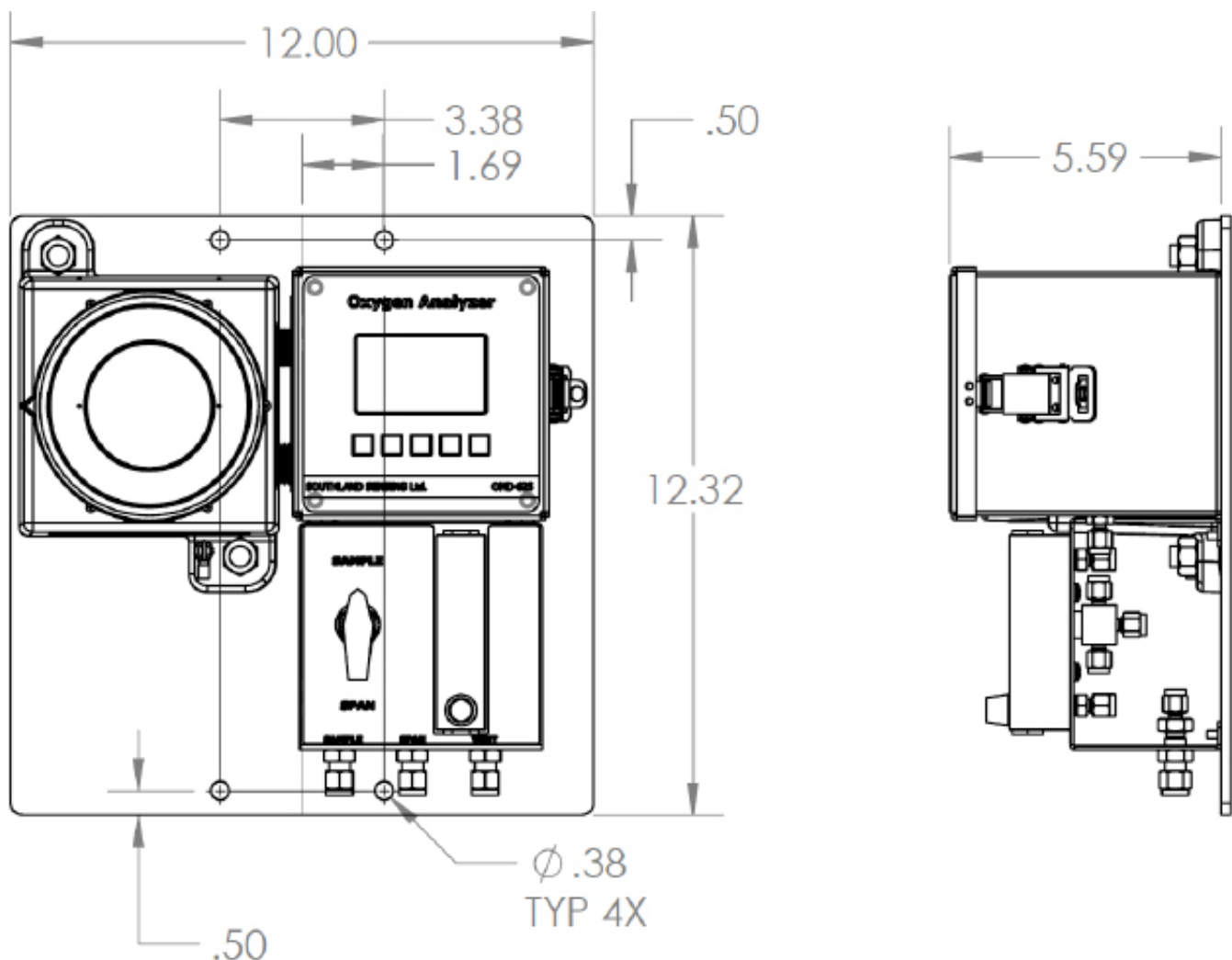

2.3.1 Electrical Connections (VAC)

This section is for AC powered analyzers, if your analyzer is DC powered proceed to the next page.



Incoming power/signal output connections are made to the green terminal block located on the Back of the unit.

Do not supply voltage more than specified in this manual and noted on the analyzer label inside of the unit.

Shielded cable is recommended when connecting power and signal output.



Voltage: 100 - 240 VAC
Max Current: 100 mA



Avoid electrostatic discharge



Follow your local electrical authority for proper procedure.

It is also recommended to make sure you have the proper seals for your conduit to meet your required installation consideration. Check with your local electrical authority.



** Note: This device is designed to be integrated with a PLC or DCS system. The power input should be 100 - 240 VAC. The electronics self generate a 4 - 20mA analog output.

If optional RS485 Modbus RTU is not included J3 connectors will not be loaded.

DO NOT hook up power to either the ANALOG OUTPUT or RANGE ID as the circuit will be damaged.

Note: For proper earth grounding, reference section 2.3.3.

2.3.2 Electrical Connections (VDC)

This section is for DC powered analyzers, if your analyzer is AC powered go to the previous page.



Incoming power/signal output connections are made to the green terminal block located on the Back of the unit.

Do not supply voltage more than specified in this manual and noted on the analyzer label inside of the unit.

Shielded cable is recommended when connecting power and signal output.

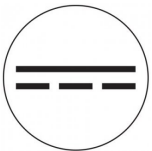

Voltage: 10 - 24 VDC
Max Current: 100 mA



Avoid electrostatic discharge



Follow your local electrical authority for proper procedure.

It is also recommended to make sure you have the proper seals for your conduit to meet your required installation consideration. Check with your local electrical authority.



** Note: This device is designed to be integrated with a PLC or DCS system. The power input should be 10 - 28 VDC. The electronics self generate a 4 - 20mA analog output.

If optional RS485 Modbus RTU is not included J3 connectors will not be loaded.

DO NOT hook up power to either the ANALOG OUTPUT or RANGE ID as the circuit will be damaged.

Note: For proper earth grounding, reference section 2.3.3.

2.3.3 Earth Grounding The Analyzer

Analyzer Ground Terminal Must Be Connected to Earth Ground. Conductor Size Must Be At Least The Size Of The Power Supply Input Wire.

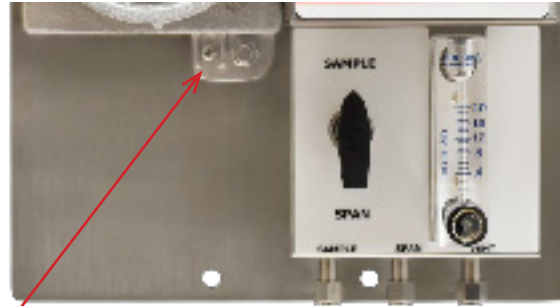

Analyzer Ground Terminal Must Be Ground

2.4 Gas Connections

Gas connections are made via 1/4" compression tube fittings. The gas connections are located below the sample system on the bottom right. Sample connections are designed for your process gas. Span connections are designed for a certified bottle of calibration gas (required). Vent is the outlet, typically designed to vent to the atmosphere, a flare stack, or per your local regulations.

2.5 Installing the H2S Sensor

The H2S-625 can accept either an H2S-1x (200 ppm max), H2S-2x (2000 ppm max), or H2S-3x (10,000 ppm max) hydrogen sulfide sensor for trace H2S analysis. For help selecting a sensor, contact your local sales representative or the factory.

Prior to installing the sensor, it is important to ensure that the gas lines are hooked up and the unit is ready to purge. Connect the process gas line and set your flow between 0.5 - 1.5 SCFH. Ideally, both the span connection and sample connection will have the same flow. We recommend 0.5 to 1.5 SCFH. It is necessary to match the flow rate of the SPAN bottle and process gas to maximize accuracy.

To install the sensor:

- Open up the square enclosure which will give you access to the sensor housing.
- Remove the cell holder cap by unscrewing the stainless steel collar.
- Lift the stainless steel collar off and set it aside.
- Remove the sensor from its packaging.
- Visually inspect the sensor for damage. If damaged, notify the factory immediately.
- Inspect the O-ring for cracks, replace if necessary. **Always lubricate your O-rings.**
- Place the sensor inside the housing with the white sensing element facing down and the circuit board facing up.
- Tighten collar. Hand tight is acceptable to create an air-tight seal.
- Install the flat ribbon cable to the back of the circuit board (see photo below)
- Make sure the contact pins on the ribbon cable align with the contact pins on the circuit board connector. The ribbon cable contact pins should be facing towards the center of the sensor.
- If the analyzer has not been calibrated, refer to section 4.1 for more information.
- The sensor / analyzer should be calibrated every 1 - 3 months with a certified bottle of SPAN gas.

H2S Sensor Front and Rear View



Front View
(Sensing Surface)



Rear View
(Circuit Board)

Ribbon Cable Connection

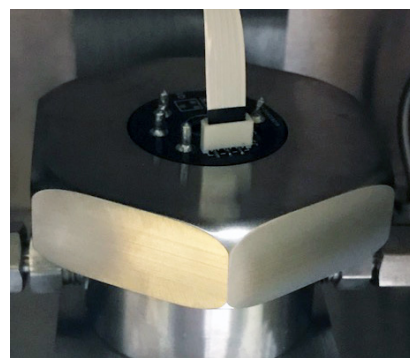

2.6 Integral Sample System Flow Diagram

Southland Sensing Ltd. strives to select the highest quality sample system components in the market. All gas connections are made via compression tube fittings. Our valves are high quality and leak tight which we rigorously test in our environmental chamber. Our flow indicators / flow meters are from Dwyer, an industry recognized leader in flow control. When dealing with critical applications such as petrochemical processing and natural gas extraction, we want to make sure we can deliver a high quality sample system and we do so by partnering with some of the best brands in the market.

Along with our standard sample system as shown below, we can also custom design sample systems to meet unique applications including the additional of moisture filters, pressure regulators, etc. For more information on a custom solution for your application, please contact your local distributor or the factory.

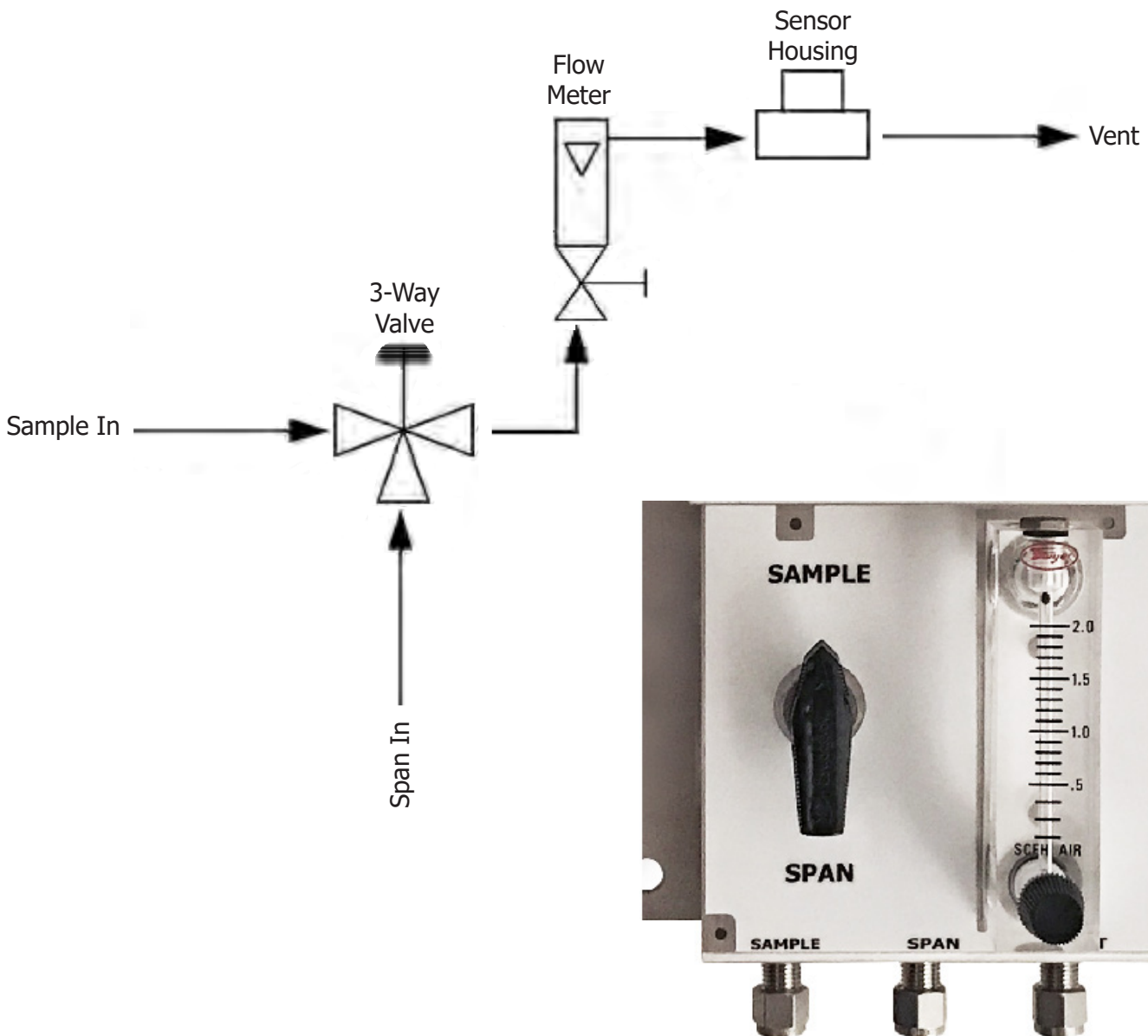

3.1 Understanding the Controls and their Operation

The H2S-625 Hydrogen Sulfide Analyzer is a feature packed unit with an easy-to-use menu interface. The key attributes within the menu are the ability to select a measurement range manually or using the auto-range mode, to calibrate the unit with a known gas, also referred to as a SPAN Calibration or SPAN CAL, and to perform a zero calibration (if necessary, for most applications it is not required).



All features are programmable / selectable through the MENU button. The UP / DOWN buttons will allow you to select your set points and the ENTER button saves the data. If you want to cancel your selection, or return to the previous screen the escape key ESC will allow you to do this. Once the unit starts up, the following home screen will appear:

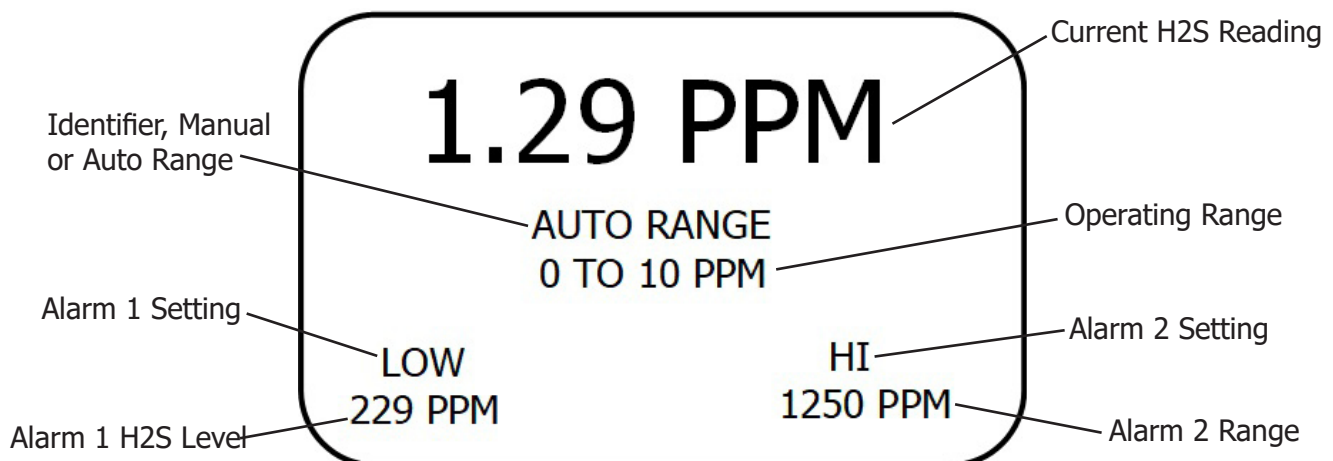

3.2 Measurement Range Overview

The H2S-625 hydrogen sulfide analyzer allows the user to field select 4 available ranges - custom ranges can be programmed in the built-in menu, see Section 3.5. These ranges can be selected in manual mode, meaning they are locked into that range by the user, or they can be set to auto-range so the analyzer will adjust to give you the best full scale resolution.

When using the Manual-Range mode the Manual Range locks the 4 - 20mA output to a single range, and the display will continue to operate in auto-range mode giving the user the full spectrum of analysis ranges. Other manufactures lock the display as well - the problem is if you over-range and the display is locked you have no idea what your hydrogen sulfide value is. The H2S-625 solves this issue with a display that auto-ranges and the ability to manually lock the analog outputs.

To select Auto-Range or Manual-Range Mode, from the HOME screen, press the MENU key and the display will indicate:

Using the UP / DOWN keys to change which option is highlighted will allow the user to select AUTO-RANGE, which will allow the unit to cycle through all five ranges, or MANUAL RANGE which will allow the user to select a specific range.

Decide which option will work best for your application. Highlight the selection and press the ENTER key. If you have selected the AUTO RANGE option, it will blink for a second indicating this was selected. If you selected the MANUAL RANGE option, the following screen will be brought up:

H2S-1x: 0 - 10 ppm, 0 - 50 ppm, 0 - 100 ppm, 0 - 200 ppm
H2S-2x: 0 - 100 ppm, 0 - 500 ppm, 0 - 1000 ppm, 0 - 2000 ppm
H2S-3x: 0 - 100 ppm, 0 - 2000 ppm, 0 - 5000 ppm, 0 - 10000 ppm

If a custom range has been set, it will appear below the lowest range.

Use the UP / DOWN keys to highlight the range to be selected and press the ENTER key. The selected range will blink for a second indicating the range has been selected.

Press the ESC key to move back to the previous screen.

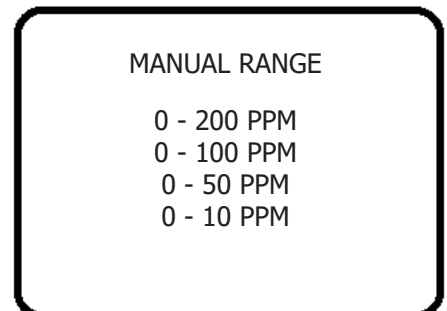
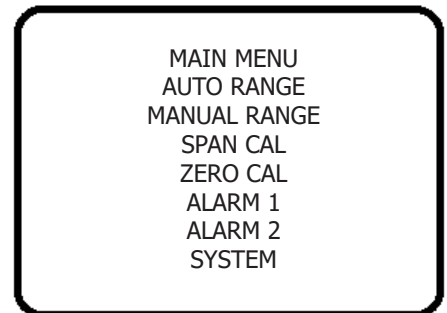

3.3 Analog Output

**** Caution: Integral 4 - 20mA converters are internally powered and do not require external power. DO NOT supply any voltage across these terminals as the 4 - 20mA output will be damaged. It is also important to assure proper grounding of the external recording device such as a PLC, DCS prior to connecting the 4 - 20mA.**

The H2S-625 is equipped with a 4 - 20mA analog output. When physically connecting the analog output, refer to the circuit board pinout in section 2.3

To verify the signal output of the 4 - 20mA circuit is working properly, connect an ammeter across the (+) and (-) pins. With no hydrogen sulfide sensor connected, it should read approximately 4 mA. If a sensor is installed you can verify the signal matches with the following formula:

$$\text{Signal Output (mA)} = [(\text{Reading} / \text{Full Scale Range}) \times 16] + 4$$

For example, if we are reading 500ppm on the 1000 ppm range:

$$\text{Signal Output (mA)} = [(500/1000) \times 16] + 4$$

$$\text{Signal Output (mA)} = 12\text{mA}$$

Some PLC's prefer a 1 - 5V DC analog output. The output can be configured for either 4-20 mA or 1-5 VDC using the built-in menu. Enter the MENU and select SYSTEM, select OUTPUT TYPE and it will allow you to select either analog output (4 - 20mA or 1 - 5V DC).

3.4 Advanced Integral Alarms

The H2S-625 Hydrogen Sulfide Analyzer is equipped with 2 advanced relay contact alarms. These alarms can be configured as normally open or normally closed, have a delay mode built-in, and can be enabled or disabled when necessary.

The alarms are rated at 5A @ 230VAC. If you are connecting to solenoid valves or a pump whose current can fluctuate greatly, it is advisable to use a slave relay to ensure no damage occurs to the electronics.

The procedure for setting Alarm 1 and Alarm 2 is identical. To begin, highlight the alarm configuration you want to adjust using the UP / DOWN keys in the analyzer MENU and press ENTER.

To adjust the value setpoint of ALARM 1 simply highlight ALARM 1 and press ENTER. Select the ADJUST ALARM option, where you will be able to adjust the levels using the UP / DOWN buttons. To set a PPM level alarm simply hold the DOWN button until you get below 1%. To set the alarm press ENTER.

The alarm function allows the user to set the alarm to trigger the relay contacts as a HIGH alarm or a LOW alarm. Simply open the ALARM 1 menu and UP or DOWN to meet your requirements.

The alarm has a built in DELAY TIME. This is ideal to use when you are working on your process and do not want to have the alarm relay contacts trip. You will set this in a similar fashion to setting the alarm. The DELAY TIME is in minutes, so adjust the value accordingly.

The alarm can also be enabled / disabled should it be hooked up but not required. Highlight ALARM ON/OFF using the UP / Down keys to and press the ENTER key.

The alarms can function as normally open or normally closed. This selection will be chosen when hooking up the wiring, it is not completed through the software. See the wiring diagram in section 2.4 for more information.

If you any questions about the ALARM functions should arise, please contact the factory for assistance or technical questions.

MAIN MENU
AUTO RANGE
MANUAL RANGE
SPAN CAL
ZERO CAL
ALARM 1
ALARM 2
SYSTEM

ALARM 1 MENU

ALARM ON/OFF
ALARM TYPE
ADJUST ALARM
DELAY MODE

3.5 Setting a Custom Range

The H2S-625 Hydrogen Sulfide Analyzer can have a custom range programmed into it in case you need a specific non-standard range. Once you have set your custom range, you can select it in the Manual Range menu to lock the 4-20 mA output to that range.

To set a custom range, perform the following steps:

Press the MENU button to go into the onboard menu. Use the UP/DOWN buttons to scroll down to SYSTEM and press the ENTER button.

```
MAIN MENU
AUTO RANGE
MANUAL RANGE
SPAN CAL
ZERO CAL
ALARM 1
ALARM 2
SYSTEM
```

Scroll down to highlight CUSTOM RANGE and press ENTER.

```
SYSTEM MENU

OUTPUT SIM
OUTPUT CAL
MODBUS ID
CUSTOM RANGE
```

The value shown will be the upper value of the range, in this case the custom range is going to be 0-995 PPM. Use the UP button to increase the value, and the DOWN button to decrease it. Press ENTER to lock in the value, or ESC to return to the menu.

```
995 PPM

UP-INCREASE
DOWN-DECREASE
ENTER TO CAL
ESC TO EXIT
```

3.6 Output Simulation

Caution: Integral 4 - 20mA converters are internally powered and do not require external power. DO NOT supply any voltage across these terminals as the 4 - 20mA output will be damaged. It is also important to assure proper grounding of the external recording device such as a PLC, DCS prior to connecting the 4 - 20mA.

The H2S-625 allows the user to simulate an analog output to calibrate a PLC or DCS system. To accomplish this, the H2S-625 will self generate a 4mA, 8mA, 12mA, 16mA or 20mA signal output. Important note, this output simulation can be done with the hydrogen sulfide sensor installed and purging on gas.

To simulate the output, the user will want to enter the MENU and select SYSTEM. From here, the user can select OUTPUT SIM which will then give them the option of what mA signal they wish to use. Move the cursor UP or DOWN to the mA desired and the analog output of the unit will adjust. For example, if you move the cursor to the 12mA, the output will change to 12mA. Once calibration of the PLC or DCS system is complete, hit ENTER or ESC to return to the HOME screen.

3.7 Output Calibration

The H2S-625 is equipped with a protocol to adjust the 4mA and 20mA signal output to account for signal degradation over long copper wires. This might occur in the field if you have 100 feet or more of cable between your H2S-625 and control panel.

To adjust the analog output, hook an ammeter or PLC up to the 4 - 20mA output. Enter the MENU screen and go to SYSTEM. From here, enter the OUTPUT CAL and it will prompt you to adjust the 4mA output. Press the UP or DOWN button to adjust, keep pressing the button if you need additional adjustment. Ignore the number on the display as this is an internal calculation, the ammeter or PLC system would be the appropriate way to verify, once it is reading 4mA hit ENTER. Once complete it will prompt you to do the same adjustment for the 20mA.

An important note, the sensor can be installed for this adjustment and does not need to be removed as is the case with competitive equipment. The electronics isolate out the sensor and allow for a nearly perfect 4mA and 20mA scale adjustment.

If the user prefers to calibrate the PLC by simulating a current such as 4mA, 8mA, 12mA, 16mA or 20mA, please refer to section 3.6.

4.1 Span Calibration using a Certified Span Gas

Calibration involves using a known span gas to match and adjust the hydrogen sulfide sensor / analyzer combo to a known value. For this section, we will focus on using a certified span gas from your local air separation company. When using a certified bottle, it is recommended to get a span gas with 50 ppm H₂S for the H₂S-1x sensor, 100 ppm for the H₂S-2x sensor, and 1000 ppm for the H₂S-3x sensor. Contact your local supply company to see what may be available.

CAUTION: Breathing H₂S at levels above 100 ppm may be fatal. Exercise extreme caution and ensure you are wearing proper PPE and working in a well-ventilated area when calibrating an H₂S-1x or H₂S-3x sensor.

Calibration using Certified Span Gas:

It is recommended to read through the calibration prior to performing an air calibration to ensure all instructions are understood. Consult the factory if any questions arise.

When installing a new sensor, after connecting the ribbon cable let it sit for a few minutes to make sure it reads <0.05 ppm before calibration.

Connect the gas span line and set the pressure / flow per section 2.4 of the users manual.

Once the gas is flowing, let the reading stabilize for about 3 - 5 minutes and then proceed (consider longer if sensor is still trending down, very important when trying to calibrate).

SPAN CALIBRATION: To calibrate the indicator, press the MENU key and use the UP/DOWN keys to highlight the SPAN CAL option and press the ENTER key.

Use the UP / DOWN key until the reading on the display matches the value of your SPAN gas. For example, if your SPAN gas is 50 ppm adjust the display UP or DOWN until it reads 50 ppm.

Press the ENTER key and the display will show "PASSED" or "FAILED." If passed you can put your sensor into service measuring your sample gas. If failed, repeat calibration steps or consult the factory

Calibration should occur every 1-2 months minimum for accurate readings.

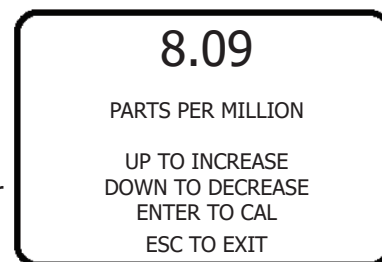
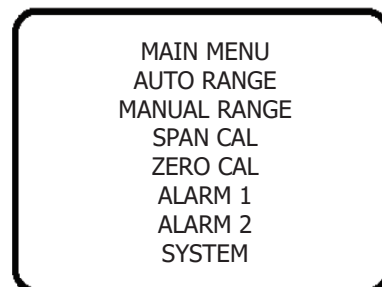

4.2 Procedure for Replacing the Hydrogen Sulfide Sensor

The characteristics of a precision electrochemical fuel cell are similar to those of a battery. They both provide an output that is nearly constant throughout their useful life and simply fall off sharply towards zero at the end. With the H2S sensors you should get approximately 1 - 3 years of life depending on the application.

Typically with an H2S sensor, if you are measuring near zero periodic calibration is needed to verify the sensor is working properly. Failure to calibrate the sensor during the calibration process is the main indicator that it is time to replace the sensor. Calibrations should occur once every 1 - 3 months or as your application requires. Check section 4.1 for more instructions on calibration.

**** Note, make sure to read section 2.5 "Installing the Hydrogen Sulfide Sensor" before replacing the sensor.**

No tools are required to replace the sensor. Open the front of the analyzer then simply unscrew (counter-clockwise) the collar on the housing inside. Once free, open the top portion of the sensor housing exposing the old hydrogen sulfide sensor. Remove the old hydrogen sulfide sensor, unplug the ribbon cable, and dispose of it like you would a lead-acid battery in accordance with your local regulations.

Remove the new sensor from its package. Check the O-ring on the front of the sensor to verify it is lubricated and has no cracks. Place the sensor sensing membrane side down in the sensor housing with the circuit board facing up. Proceed to re-engage the stainless steel collar making sure it is hand tight. No tools are required, hand tight with a good O-ring will create a leak-free seal. Once the collar is re-engaged insert the ribbon cable into the connector on the back of the sensor. Note that the metal contacts should be facing in towards the center of the sensor, making contact with the mating connector.

After the sensor has been replaced, proceed to the Span Calibration section.

4.4 Troubleshooting

For troubleshooting and advanced maintenance techniques, please contact your factory representative for assistance.

Email: sales@ssH2S.com
Ph: 1-949-398-2879

5.1 Spare Parts List

Spare Parts List - H2S-625

Replacement Hydrogen Sulfide Sensors:

| | |
|--------|--|
| H2S-1x | PPM Hydrogen Sulfide Sensor, 200 PPM Max |
| H2S-2x | PPM Hydrogen Sulfide Sensor, 2000 PPM Max |
| H2S-3x | PPM Hydrogen Sulfide Sensor, 10000 PPM Max |

Replacement Parts:

| | |
|----------------|---|
| EX-PCB-10047-4 | Circuit Board for H2S-625 Gen 2 |
| EX-PCB-10041-2 | Power Board, DC H2S-625 Gen 2 (4-Wire DC) |
| EX-PCB-10041-3 | Power Board, DC H2S-625 Gen 2 (4-Wire DC + Modbus) |
| EX-PCB-10041-4 | Power Board, DC H2S-625 Gen 2 (100 - 240VAC) |
| EX-PCB-10041-5 | Power Board, DC H2S-625 Gen 2 (100 - 240VAC + Modbus) |
| EX-PCB-10049 | MODBUS RTU RS485 Add On Board (Optional) |
| ORING-1001 | Sensor Housing O-ring |
| FUSE-1001 | Replacement Fuse H2S-625 |

For additional troubleshooting or replacement parts, please contact the factory:
sales@sso2.com; Ph: 1-949-398-2879

5.2 Warranty

Hydrogen Sulfide Analyzer / Sensor Warranty

The design and manufacture of our analyzers and precision electrochemical hydrogen sulfide sensors conforms to established standards and incorporates state of the art materials and components for superior performance while still maintaining minimal cost of ownership. Prior to shipment, every analyzer / sensor is thoroughly tested by the manufacturer. When operated and maintained in accordance with the Owner's Manual, the units will provide many months of reliable service.

Coverage

Under normal operating conditions the analyzers / sensors are warranted to be free of defects in materials and workmanship for the period specified in accordance with the most recent published specifications, said period begins with the date of shipment by the manufacturer. The manufacturer information and serial number of this analyzer / sensor are located visibly on the unit. Southland Sensing Ltd. reserves the right in its sole discretion to invalidate this warranty if the serial number does not appear.

Limitations

Southland Sensing Ltd. will not pay for: loss of time, inconvenience, loss of use, or property damage caused by the hydrogen sulfide analyzer / sensor or its failure to work.

Exclusions

This warranty does not cover installation, defects resulting from accidents, damage while in transit to our service location, damage resulting from alterations, misuse or abuse, lack of proper maintenance, unauthorized repair or modification of the analyzer, affixing of any label or attachment not provided with the analyzer, fire or flood.

Service

Call Southland Sensing Ltd. at 1-949-398-2879 (or e-mail sales@sso2.com). Trained technicians will assist you in diagnosing the problem.

5.3 Material Safety Data Sheet (MSDS)

Contact the factory for the MSDS.

5.4 Certificate of Conformance

Model Number: H2S-625 Hydrogen Sulfide Analyzer
Serial Number: _____

Sensor Selection: () H2S-1x Hydrogen Sulfide Sensor
() H2S-2x Hydrogen Sulfide Sensor
() H2S-3x Hydrogen Sulfide Sensor

Serial Number: _____

Sensor Housing Selection: H3 Flow Through Sensor Housing

Sample System: () Sample / Span valve, Flow Meter, 1/4" Compression Tube Fittings
() Sample / Span valve, Flow Meter, 6mm Compression Tube Fittings
() Delete Sample System; Fittings: _____

Configuration:
Ranges: () 0 - 10 ppm, 0 - 50 ppm, 0 - 100 ppm, 0 - 200 ppm
() 0 - 100 ppm, 0 - 500 ppm, 0 - 1000 ppm, 0 - 2000 ppm
() 0 - 100 ppm, 0 - 2000 ppm, 0 - 5000 ppm, 0 - 10000 ppm
Power: () 12 - 24 V DC 4-Wire
() 12 - 24 V DC 4-Wire + Bi-directional MODBUS RS485 RTU
() 100 - 240 V AC
() 100 - 240 V AC + Bi-directional MODBUS RS485 RTU

Analog Output: () 1 - 5 V DC Range ID Output
() 4 - 20 mA DC Range ID Output

Display: Backlight

We certify that the parts shipped to you are manufactured in the USA and conform to all requirements of the Purchase Order. These parts have been manufactured and tested to the highest quality standards and in accordance with all required specifications, instructions and technical drawings.

Date: _____ Signature: _____

5.5 MODBUS RS485 RTU Bi-Directional Communication Protocol

MODBUS RTU Protocol

The H2S-625 uses MODBUS RTU at 19200 Baud, 8 bits of data, 1 stop bit, and Even Parity. The communication settings are not adjustable on the H2S-625. The MODBUS ID number is set as 1.

MODBUS RTU structure looks like this:

- DEVICE ADDRESS 1 char ID = 1
- FUNCTION CODE 2 chars
- REGISTER NUMBER 2 chars
- REGISTER COUNT n chars Data + length, depends on message length
- DATA n chars, depends on message length
- CRC CHECKSUM 4 chars , Hi and Lo Error

The MODBUS RTU Checksum is CRC16.

The H2S-625 will respond to MODBUS commands 4, 6, and 16.

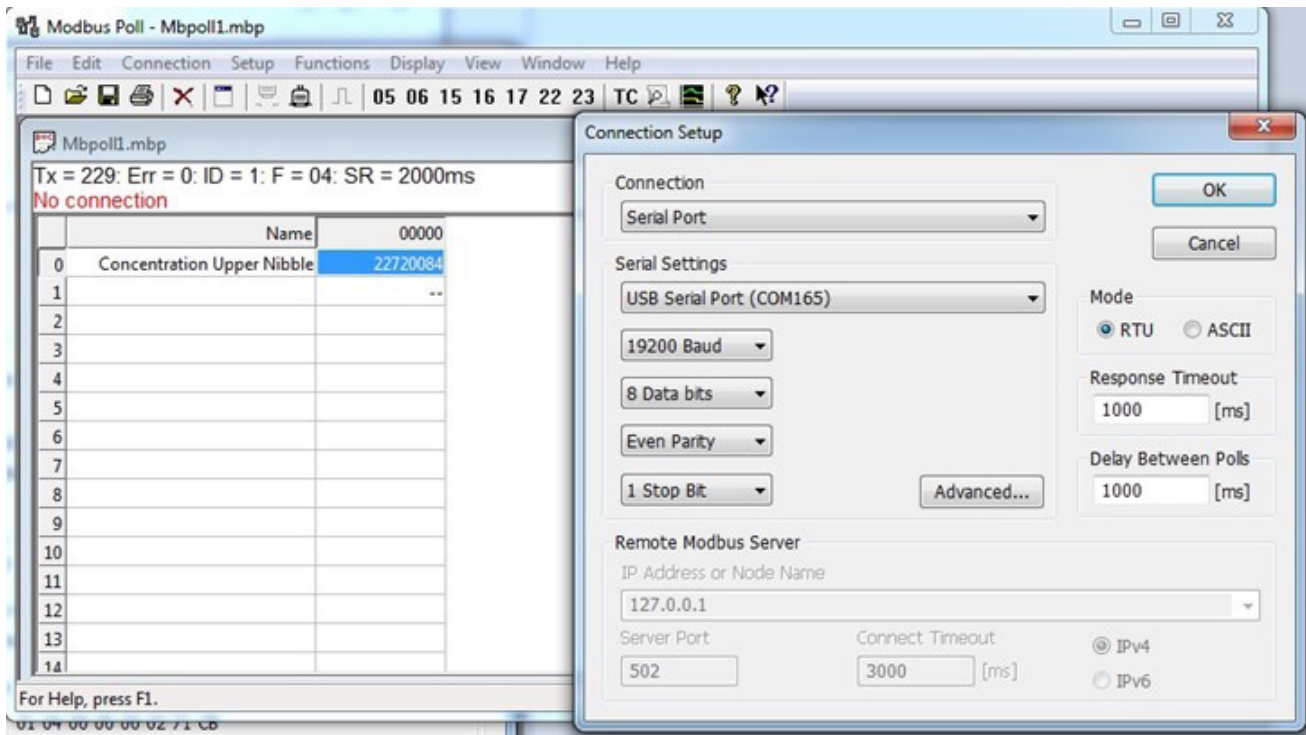

5.5_2 MODBUS RS485 RTU Bi-Directional Communication Protocol

MODBUS RTU Protocol

Gas concentration when read from or when written to the H2S-625 is in PPM, as XX XX XX.XX, ie. 22.7 Percent Oxygen on the display would be 227,194.82 and would appear as 22719482.

Command 4 is for reading input registers, we use this when reading gas concentration. This will return the gas concentration in PPM, regardless of the manual range setting. The MODBUS command to read input registers is as follows, “:01 04 00 00 00 02 71 CB”.

- “01” Device ID,
- “04” Function – Read Input Registers, “00” 1st Register High Byte,
- “00” 1st Register Low Byte,
- “00” Number of Registers Hi Byte, “02” Number of Registers Low Byte,
- “71” Error Check Lo
- “CB” Error Check Hi

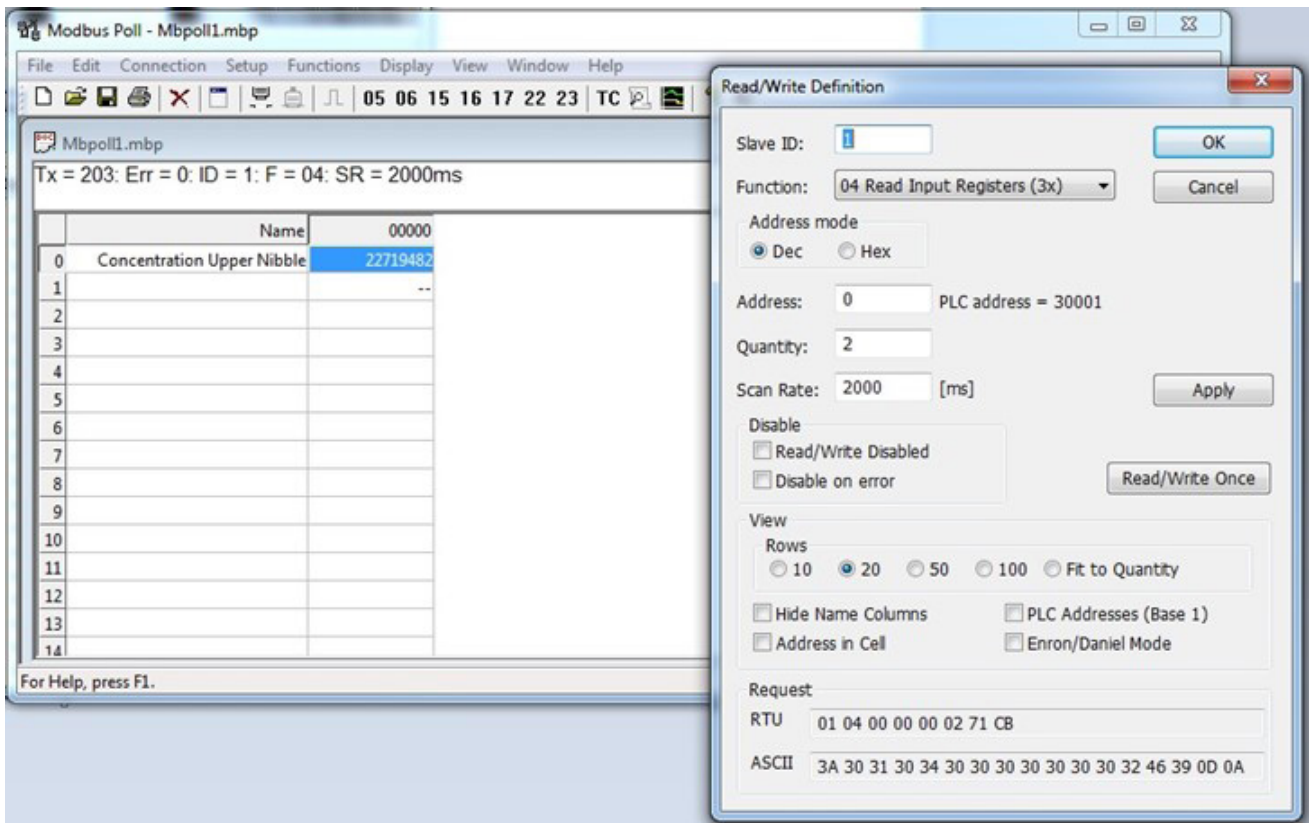

5.5_3 MODBUS RS485 RTU Bi-Directional Communication Protocol

MODBUS RTU Protocol

Command 4 will return the gas concentration, the following example is for MODBUS ID #1, and is returning 22.7 Percent or 227,194.82 PPM, " 01 04 04 01 5A A5 A6 21 41 ". In this instance 01 5A A5 A6 Hex = 22717862 Decimal, or 227,194.82 PPM

- "01" Device ID,
- "04" Function – Read Input Registers,
- "04" Byte Count – Always 4 bytes
- "01", Data Byte Hi, #1
- "5A", Data Byte Lo, #1
- "A5", Data Byte Hi, #2
- "A6", Data Byte Lo, #2
- "21", Error Check Lo
- "41", Error Check Hi

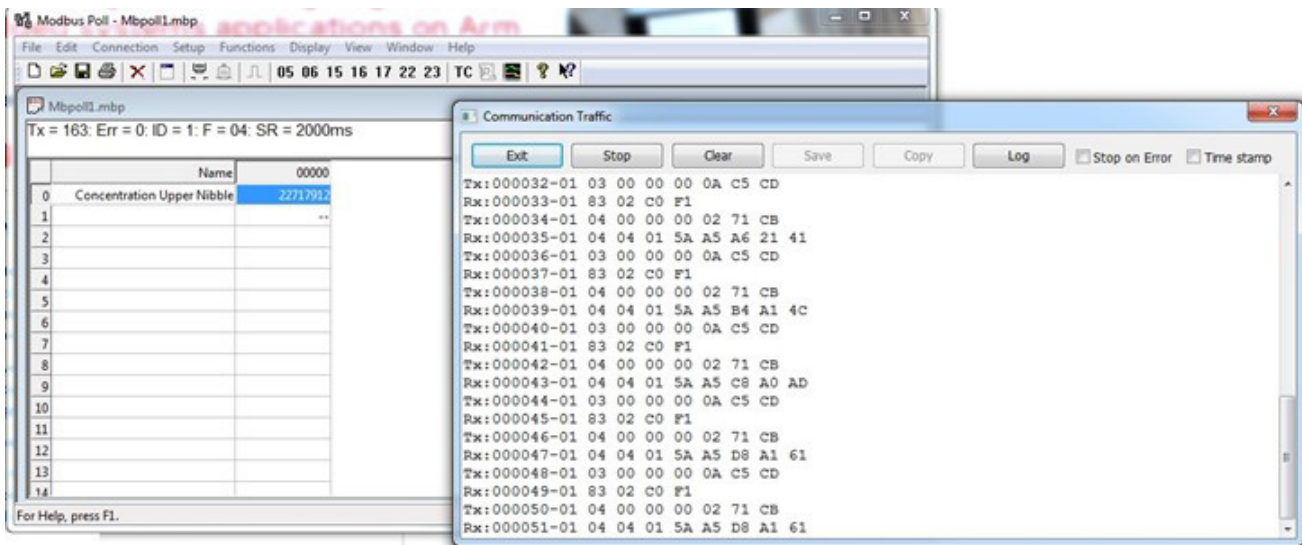

5.6 Explosion Proof Electrical Connections

Electrical connections require an approved explosion proof cable gland / conduit sealing fitting and packing around wires and cables (for incoming power for the analyzer electronics and analyzer outputs) coming into and out of the explosion proof enclosure that houses the power supply.

Full compliance with hazardous area electrical code requires the user to supply cable gland, fittings and /or conduit commensurate with the level of protection or classification desired. To maintain the ATEX / IECEx / UKEX certification of this unit, the user must install ATEX / IECEx / UKEX approved components according to the published directives.

Additional Specific Requirements:

- 1.) Only cable glands and conduit sealing fittings certified for protection type 'd' and have an IP66 rating may be used.
- 2.) All unused device openings must be fitted with a certified close-up plug with protection types 'd' and have an IP66 rating may be used.
- 3.) Only one Hazardous Location Solutions reducer shall be used with any single cable entry on the associated equipment.
- 4.) The cable specific minimum ambient temperature is marked on the line bushing and it is detailed in the shipping documents.
- 5.) Stopping plugs are not to be used in conjunction with any other cable entry device.

To fill an open hole, if the user needs to install any blanking element / glands themselves, the user will need to source a 1/2 inch NPT element.

Note: The following instruction is supplied from information and data supplied by a reputable gland manufacturer which we believe is reliable and is given in good faith. Since the methods of application and conditions under which our products are put to use are beyond our control, we are not able to guarantee the application and/or use of same. The user assumes all risks and liability in connection with the application and use of our products.

Instruction Guide: All products should be installed in accordance with all relevant Installation Standards and Codes of Practice e.g. EN/IEC 60079-14, NEC/CEC.

- Installation should only be carried out by a suitably trained person.
- Under no circumstances should installation be carried out under live conditions.
- The installer should ensure that no damage occurs to any thread or form of seal during installation. Where component is plated care should be taken to prevent damage or chipping.
- Element (1/2 inch NPT in size) should be installed hand tight and then tightened a further 1 to 2 full turns, wrench tight or tool secure.
- Ensure that the torque values are applied and do not exceed the maximum torque that can be applied to the enclosure to achieve IP ratings.

5.7 Potential Electrostatic Charging Hazard

Static electricity is the electrical charge produced on two dissimilar materials through physical contact and separation caused by the imbalance of positive and negative charges between the two.

As an electrostatic charge accumulates, the electric fields and voltages increase. If the charge is unable to bleed off to ground when the electric field exceeds the insulating properties of the atmosphere, a static discharge hazard can occur.

For the 625 series analyzer, depending on the environmental conditions, there is a risk of this occurring between the stainless steel metal box and the polyester membrane keypad. It is recommended to not touch the buttons unless you have ensured there is a low potential difference between the user and the surface being touched, or the user should use an insulating medium to touch the surface. Additionally the equipment should be installed in an area where electrostatic charge is not likely to form, such as away from direct airflow, etc.

In some installation environments the user can apply a conductive coating to the overlay to reduce the risk of an electrostatic charging hazard. The user would need to decide the acceptable durability of the coating material with respect to the environmental conditions.