

OMD-625 Oxygen Analyzer

ATEX and IECEx Certified for Hazardous Areas

Part 1 Introduction

- 1.1 General Introduction
- 1.2 Principle of Operation - The Oxygen Sensor
- 1.3 OMD-625 Specifications
- 1.4.1 General Safety Information (VAC)
- 1.4.2 General Safety Information (VDC)
- 1.5 Location Installation Considerations
- 1.6 Safety Considerations

Part 2 Installation

- 2.1 Receiving Your New Oxygen Analyzer
- 2.2 Mounting The Oxygen Analyzer
- 2.3.1 Electrical Connections (VAC)
- 2.3.2 Electrical Connections (VDC)
- 2.3.3 Earth Grounding The Analyzer
- 2.4 Gas Connections
- 2.5 Installing The Oxygen Sensor
- 2.6 Integral Sample System Flow Diagram
- 2.7 Sensor Selection

Part 3 Operation

- 3.1 Understanding The Controls and Their Operation
- 3.2 Manual Range Output Adjustment
- 3.3 Analog Output 4 - 20mA or 1 - 5 VDC
- 3.4 Advanced Integral Alarms
- 3.5 Setting a Custom Range
- 3.6 Output Simulation
- 3.7 Output Calibration

Part 4 Maintenance

- 4.1 Span Calibration Using Ambient Air
- 4.2 Span Calibration Using Certified Span Gas
- 4.3 Procedure for Replacing the Sensor
- 4.4 Troubleshooting
- 4.5 Zero Calibration

Part 5 Annexures

- 5.1 Spare Parts List
- 5.2 Warranty
- 5.3 Material Safety Data Sheets
- 5.4 Conformance Certificate
- 5.5 Modbus Instructions
- 5.6 Explosion Proof Electrical Connections
- 5.7 Potential Electrostatic Charging Hazard

1.1 General Introduction

The Southland Sensing OMD-625 Oxygen Analyzer is a microprocessor based online unit designed for continuous measurements in a variety of hazardous area applications and gas mixtures. The Analyzer is certified for use in Zone 1 Group IIB+H2 (ATEX, IECEx and UKEX).

The analyzer was designed with the customer in mind, keeping the operations simple while still featuring a fast response and rugged design. Every effort has been made to use modern industrial components and materials which has resulted in an advanced design, excellent performance, and an overall low cost of ownership.

The analyzer has numerous options including PPM and Percent oxygen analysis. The unit can be configured for VAC or VDC power input with an isolated analog 4 - 20mA or 1-5 VDC concentration output and optional digital RS485 Modbus RTU output meeting most oxygen analysis applications.

Southland Sensing Ltd. appreciates your business and recommends reading through the complete manual to be able to get the full experience from your new oxygen analyzer.

1.2 Principle of Operation - The Oxygen Sensor

The precision electrochemical oxygen sensor used in the OMD-625 is designed and manufactured by Southland Sensing Ltd. under a strict quality procedure.

To understand how the oxygen analyzer functions, it is important to understand a little bit of the sensor characteristics.

The active components in the precision electrochemical oxygen sensor are the anode, cathode, and aqueous electrolyte which are all housed in the cell body. The oxygen molecules in the application pass through the front sensing membrane into the electrolyte, where a chemical reaction occurs and a raw electrical current is generated.

This electrical current is proportional to the amount of oxygen in the application. The analyzer then processes this raw electronic signal, compensates for temperature and barometric pressure variations, and converts the data into a parts-per-million or percent oxygen measurement value.

The oxygen concentration reading is then displayed in real time on the full backlit display and the user can automate the control of their process using any of the output signals which can be run to a PLC or other type of DCS system.



Precision Electrochemical Oxygen Sensor

Hazardous Area Online Process Oxygen Analyzer w/Sample System
ATEX and IECEx Certified for Hazardous Areas



- **Precision Fuel Cell Oxygen Sensor Technology**

- **Zone 1 IIB + H2 Applications**

- **Custom Full Scale Range (i.e. 0 - 99.5 ppm)**

- **Optional MODBUS RS485 RTU**

- **Large Backlight Display**

- **Ability to Calibrate Analog Output**

- **Measure Oxygen from 0.01ppm to 25%**

- **Intuitive User Friendly Interface**

- **Cost Effective and Low Maintenance**

- **2 Configurable Alarm Relay Contacts**

- **Output Sim (4mA, 8mA, 12mA, 16mA and 20mA)**

Optional Configurations:

- Sample System Add-On Components
- Bi-Directional RS485 Modbus RTU
- Extreme Weather Packaging
- Extended Temperature Ranges

Applications:

- Natural Gas Extraction & Pipelines
- Natural Gas Processing
- Acid (CO2) Gas Streams
- Inert, Hydrocarbon, Hydrogen Processing
- And Many Other Industrial Applications

Specifications:

Accuracy:	< +/-1% Full Scale Range*
Alarms:	2 Configurable Relay Contacts
Analyzer Range:	0 - 10/100/1000/10000ppm/25%
Optional Range 1:	0 - 1%,/5%/10%/25%/100%
Area Classification:	Zone 1 IIB + H2
Dimensions:	12" x 12" x 5.25"
Flow:	0.5 - 5.0 SCFH
Gas Connections:	1/4" Compression Tube
Output:	Isolated 4 - 20mA or 1 - 5 VDC
Power:	12 - 24 VDC 100 - 240 VAC
Pressure	0.1 - 50 PSIG Inlet, vent to atm
Response Time:	T90 in 10 Seconds
Sensor:	Precision Fuel Cell
Temperature:	0 to 50 deg C**
Warranty Sensor:	12 Months
Warranty Electronics:	12 Months
Weight:	21 lbs

* Accuracy at constant conditions

** Consult Factory For Expanded Temp Range

"Inquiry for Application Expertise"

Oxygen Analyzer:

The model OMD-625 oxygen analyzer combines a rugged design with SSO2's precision oxygen sensors. The result is a highly reliable and cost effective compact design with easy-to-use user interface designed specifically for the natural gas industry.

The oxygen analyzer is certified for use in Zone 1 IIB + H2 applications.

The oxygen analyzer is isolated both on the power input and analog output. This eliminates most electronic gremlins seen with existing competitive equipment in the field.

Standard ranges include 0 - 10ppm, 0 - 100ppm, 0 - 1000ppm, 0 - 10000ppm, 0 - 25%.

Optional Percent Analysis Ranges: 0 - 1%, 0 - 5%, 0 - 10%, 0 - 25%, 0 - 100%.

Custom Range: The unit comes with the ability to customize a 6th range (i.e. 0 - 94.0 ppm).

Standard Power Requirements:

Input Power: 12 - 24 V DC
 Current Draw: 50 mA
 ** Optional power input choices available

Oxygen Sensor Technology:

The oxygen sensor used in the OMD-625 is based on the galvanic electrochemical fuel cell principal. All oxygen sensors are manufactured in house by Southland Sensing Ltd. under a strict quality program.

The standard cells are unaffected by other background gases such as H2, He or Hydrocarbons. The acidic cells work well when acid gases such as CO2 or natural gas are present. H2S resistant sensors are available for sour gas streams with <500 PPM H2S.

The sensors are self-contained and minimal maintenance is required - no need to clean electrodes or add electrolyte.

The SSO2 precision oxygen sensors offer excellent performance, accuracy and stability while maximizing the expected life.

Oxygen Sensors:

- TO2-133 PPM Oxygen Sensor: Trace Analysis, Standard
- TO2-233 PPM Oxygen Sensor: Trace Analysis, Acidic
- TO2-238 PPM Oxygen Sensor: Trace Analysis, < 500PPM H2S
- PO2-160 Percent Oxygen Sensor: Percent Analysis, Standard
- PO2-24 Percent Oxygen Sensor: Percent Analysis, Acidic

Oxygen sensors should be periodically calibrated. Factory recommendation is every 2 - 3 months or as the application dictates. Sensors offer excellent linearity with an air calibration, or calibrate to a certified span gas to maximize accuracy.

Order Information:

Record Part Number with selected options in Blank Indicated Area of Form

Model Number:

OMD-625 Oxygen Analyzer
 OMD-625D Oxygen Analyzer (Delete Sample System, 1/8" Compression Tube Gas Inlets)

Selected Range & Sensor:

3T	Trace Analysis Standard (TO2-133):	0 - 10ppm, 0 - 100ppm, 0 - 1000ppm, 0 - 10000 PPM 0 - 25%
4T	Trace Analysis Standard (TO2-233):	0 - 10ppm, 0 - 100ppm, 0 - 1000ppm, 0 - 10000 PPM 0 - 25%
5T	Trace Analysis < 500 PPM H2S (TO2-238):	0 - 10ppm, 0 - 100ppm, 0 - 1000ppm, 0 - 10000 PPM 0 - 25%
5P	Percent Analysis Standard (PO2-160):	0 - 1%, 0 - 5%, 0 - 10%, 0 - 25%, 0 - 100%
6P	Percent Analysis Standard (PO2-24):	0 - 1%, 0 - 5%, 0 - 10%, 0 - 25%, 0 - 100%

Electronics Package:

4	12 - 24V DC 4-wire Power
4M	12 - 24V DC Power w/ Bi-Directional MODBUS RS485 RTU
7	100 - 240V AC Power
7M	100 - 240V AC Power w/ Bi-Directional MODBUS RS485 RTU

Gas Connections:

4	1/4" Compression Tube Fittings
6	6mm Compression Tube Fittings
8	1/8" Compression Tube Fittings

OMD-625 - _____ - _____ - _____ Use This Part Number When Ordering

ATEX:

Southland Sensing Ltd.
4045 E. Guasti Rd. Suite 203, Ontario, CA 91761 USA
OMD-625 Series Oxygen Analyzer

ExVeritas 23ATEX1653X
 II 2 G
Ex db ib IIB+H2 T4 Gb
Tamb -20°C to +50°C



IECEX:

Southland Sensing Ltd.
4045 E. Guasti Rd. Suite 203, Ontario, CA 91761 USA
OMD-625 Series Oxygen Analyzer

IECEX EXV 23.0038X
 II 2 G
Ex db ib IIB+H2 T4 Gb
Tamb -20°C to +50°C



1.4.1 General Safety & Installation (VAC)

This section is for AC powered analyzers, if your analyzer is DC powered proceed to the next page.

This section summarizes the precautions applicable to the OMD-625 Oxygen Analyzer. Additional precautions specific to this analyzer are contained in the following sections of the manual. To operate the analyzer safely and to obtain the best performance, follow the basic guidelines outlines in this owner's manual.



CAUTION: This symbol is used throughout the owner's manual to caution and alert the user that this device is operated on AC Voltage (VAC)



CAUTION: This symbol is used throughout the owner's manual to caution and alert the user to recommended safety and / or operating guidelines.



WARNING: This symbol is used throughout the owner's manual to warn and alert the user of the presence of electrostatic discharge.

READ INSTRUCTIONS: Before operating the oxygen analyzer, read the instructions.

RETAIN INSTRUCTIONS: The safety precautions and operating instructions found in the owner's manual should be retained for future reference.

FOLLOW INSTRUCTIONS: Observe all precautions and operating instructions. Failure to do so may result in personal injury or damage to the transmitter.

OXYGEN ANALYZER LABEL:

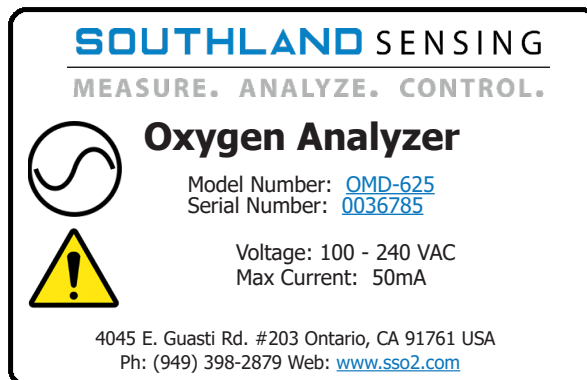

Please refer to Appendix 5.6 for making electrical connections that maintains the desired level of protection.

1.4.2 General Safety & Installation (VDC)

This section is for DC powered analyzers, if your analyzer is AC powered see the previous page.

This section summarizes the precautions applicable to the OMD-625 Oxygen Analyzer. Additional precautions specific to this analyzer are contained in the following sections of the manual. To operate the analyzer safely and to obtain the best performance, follow the basic guidelines outlines in this owner's manual.

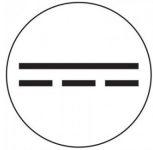

CAUTION: This symbol is used throughout the owner's manual to caution and alert the user that this device is operated on DC Voltage (VDC)



CAUTION: This symbol is used throughout the owner's manual to caution and alert the user to recommended safety and / or operating guidelines.



WARNING: This symbol is used throughout the owner's manual to warn and alert the user of the presence of electrostatic discharge.

READ INSTRUCTIONS: Before operating the oxygen analyzer, read the instructions.

RETAIN INSTRUCTIONS: The safety precautions and operating instructions found in the owner's manual should be retained for future reference.

FOLLOW INSTRUCTIONS: Observe all precautions and operating instructions. Failure to do so may result in personal injury or damage to the transmitter.

OXYGEN ANALYZER LABEL:

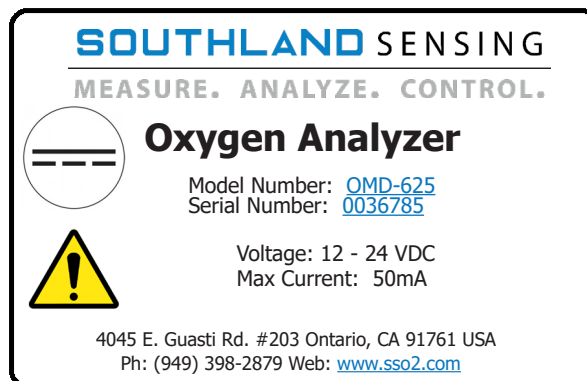

Please refer to Appendix 5.6 for making electrical connections that maintains the desired level of protection.

1.5 Location Installation Considerations

The Southland Sensing OMD-625 Oxygen Analyzer is designed to be mounted on a wall or on a pipe in a general purpose or Zone 1 IIB + H2 area. When installed outdoors in extreme cold areas a heavy duty heated enclosure is recommended. Consider also giving the analyzer a sun shield if it is going to be mounted in the direct sunlight.

Reference your local electrical authority for the proper installation. Reference section 5.6 for specific gland requirements.

Seals / glands are required on the power and signal conduit entries, reference your local electrical authority for the proper installation and section 5.6.

The analyzer is EMI / RFI protected, however it is good practice not to mount it too close to sources of electrical interference such as large transformers, motor start contactors, relays, large pumps, etc. Also avoid subjecting the analyzer to significant vibration.

Mount the unit at a suitable eye level to easily read the local display. Gas connections are located on the top right side of the analyzer, ensure there is adequate room to hook up your gas lines.

1.6 Safety Considerations

The oxygen analyzer is designed for installation into either a general purpose area, or Zone 1 IIB+H2.

The analyzer consists of two enclosures mounted on a single back panel. The small Adalet enclosure on the left side is explosion-proof and contains the electrical connections for the user such as power, alarms, analog output, and digital MODBUS output (if applicable). This explosion-proof enclosure also contains the power supply and safety components for the other enclosure. The enclosure on the right contains the analytical circuitry, the oxygen sensor, and the oxygen sensor housing. This circuitry is designed for intrinsic safety and meets requirements for Zone 1 IIB + H2.

When installing a Zone 1 IIB + H2 device please follow your local electrical code should the area need to be declassified prior to installation.

2.1 Receiving Your New Oxygen Analyzer

As soon as you receive your new oxygen analyzer carefully unpack the unit and accessories and inspect the interior and exterior of the analyzer for damage, and also verify the oxygen sensor is present.

CAUTION: Do not open the oxygen sensor packaging at this time. It is packed in a nitrogen purged bag and will be damaged if left exposed to ambient air for a prolonged period of time. It is recommended that you read through the instruction manual installation and operation sections before attempting to open the bag the oxygen sensor is packed in. For questions, please contact the factory.

If damage to any portion of the new analyzer is present, stop and report damage to the shipping company as well as the factory.

The analyzer is shipped with all materials needed to install and prepare the system for operation. In some instances, added sample system components are necessary to condition the gas sample before entering the sensor housing. Southland Sensing offers free application consultation and we encourage you to take advantage of our engineers and their expertise.

It is also important to be mindful of EMI / RFI noise interference. Protection from EMI / RFI noise is important for accurate readings.

2.2 Mounting the Oxygen Analyzer

The OMD-625 is designed to be mounted on a wall or around a pipe. See below for the mounting dimensions. If mounting in extreme temperature consider an enclosure and heater if necessary.

Refer to Part 3: Operation section of this instruction manual for more information on how to operate the controls of this oxygen analyzer.

Refer to Part 4: Maintenance section for an overview on how to calibrate the device using a certified span gas or ambient air.

A precision electrochemical oxygen sensor is included as a separate item and must be installed prior to instrument use.

CAUTION: Do not open the nitrogen filled oxygen sensor bag until you have thoroughly read the instruction manual and have made all gas and electrical connections. Please refer to section 2.5 to reference installing the oxygen sensor into the sensor housing as well as section 4.1 and 4.2 on SPAN Calibration.

OMD-625 Mounting Dimensions.

Sizes are in and inches.

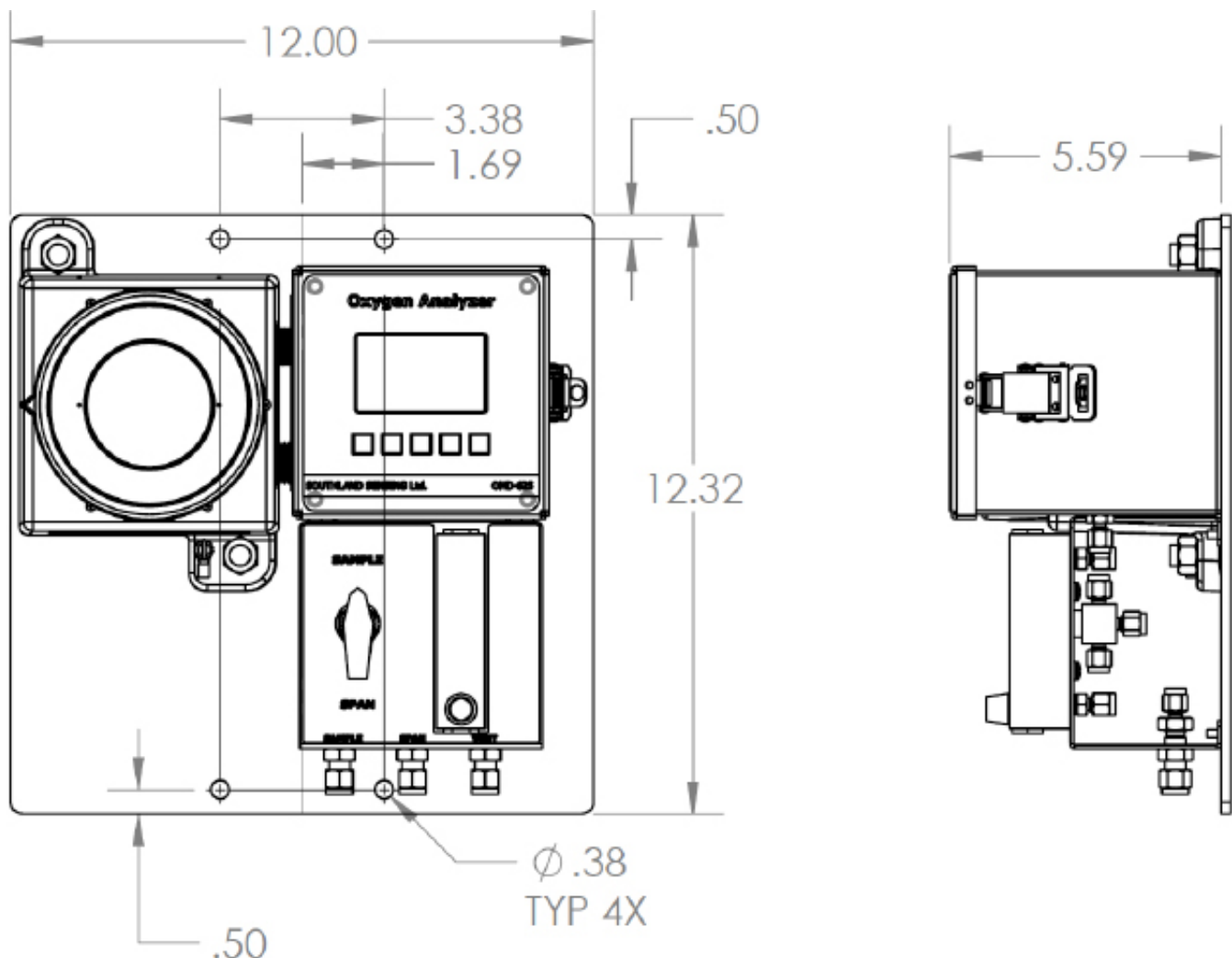

2.3.1 Electrical Connections (VAC)

This section is for AC powered analyzers, if your analyzer is DC powered proceed to the next page.



Incoming power/signal output connections are made to the green terminal block located on the Back of the unit.

Do not supply voltage more than specified in this manual and noted on the analyzer label inside of the unit.

Shielded cable is recommended when connecting power and signal output.



Voltage: 100 - 240 VAC
Max Current: 50 mA



Avoid electrostatic discharge



Follow your local electrical authority for proper procedure.

It is also recommended to make sure you have the proper seals for your conduit to meet your required installation consideration. Check with your local electrical authority.



** Note: This device is designed to be integrated with a PLC or DCS system. The power input should be 100 - 240 VAC. The electronics self generate a 4 - 20mA analog output.

If optional RS485 Modbus RTU is not included J3 connectors will not be loaded.

DO NOT hook up power to either the **ANALOG OUTPUT** or **RANGE ID** as the circuit will be damaged.

Note: For proper earth grounding, reference section 2.3.3.

2.3.2 Electrical Connections (VDC)

This section is for DC powered analyzers, if your analyzer is AC powered go to the previous page.



Incoming power/signal output connections are made to the green terminal block located on the Back of the unit.

Do not supply voltage more than specified in this manual and noted on the analyzer label inside of the unit.

Shielded cable is recommended when connecting power and signal output.

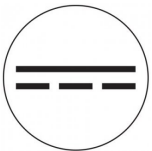

Voltage: 10 - 24 VDC
Max Current: 50 mA



Avoid electrostatic discharge



Follow your local electrical authority for proper procedure.

It is also recommended to make sure you have the proper seals for your conduit to meet your required installation consideration. Check with your local electrical authority.

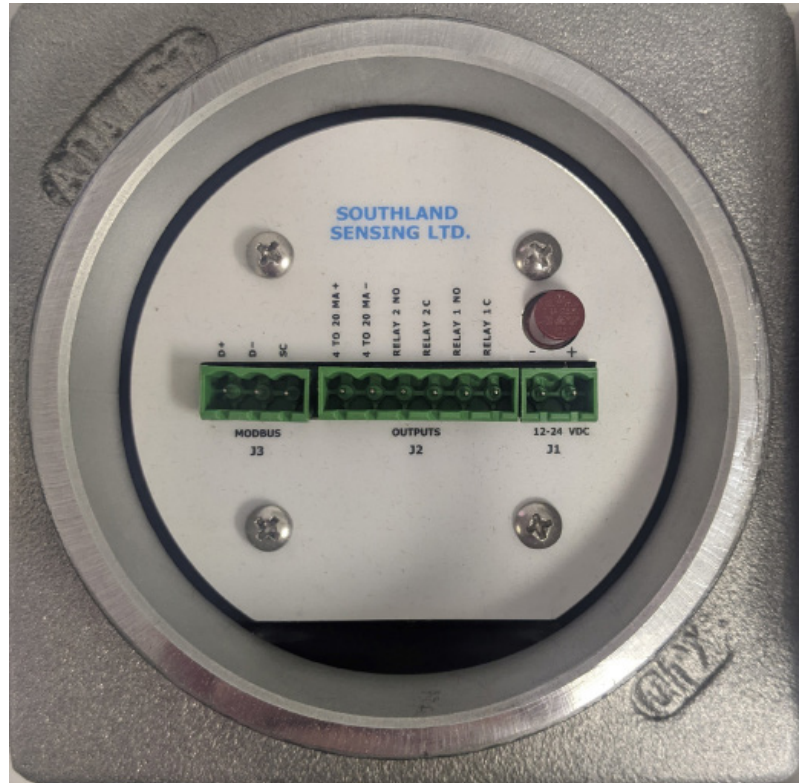

** Note: This device is designed to be integrated with a PLC or DCS system. The power input should be 10 - 28 VDC. The electronics self generate a 4 - 20mA analog output.

If optional RS485 Modbus RTU is not included J3 connectors will not be loaded.

DO NOT hook up power to either the ANALOG OUTPUT or RANGE ID as the circuit will be damaged.

Note: For proper earth grounding, reference section 2.3.3.

2.3.3 Earth Grounding The Analyzer

Analyzer Ground Terminal Must Be Connected to Earth Ground. Conductor Size Must Be At Least The Size Of The Power Supply Input Wire.

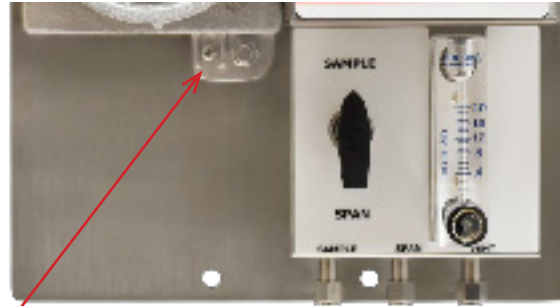

Analyzer Ground Terminal Must Be Ground

2.4 Gas Connections

Gas Connections are made via compression tube fittings directly on the analyzer. Various tube fittings sizes are available, check with the build sheet for specific gas connection sizes.

2.5 Installing the Oxygen Sensor

CAUTION: Prior to installing the oxygen sensor read section 4.1 on performing a span calibration.

The OMD-625 can accept either a TO2-133 or TO2-223 (for CO₂ applications, i.e. natural gas) oxygen sensor for trace oxygen analysis. For percent measurement, the OMD-625 can accept either a PO2-160 or PO2-24 (for CO₂ applications) oxygen sensor. For applications with <500 ppm H₂S we offer an H₂S resistant sensor: the TO2-238 for trace oxygen analysis. For help selecting a sensor, contact your local sales rep or the factory.

Prior to installing the sensor, it is important to make sure that the analyzer gas lines are hooked up and the unit is ready to purge with a zero or process gas. Connect the zero gas line and set your flow between 0.50 - 5.0 SCFH.

To Install the Sensor:

- Open the front of the analyzer using the latch on the right side.
- Remove the cell holder cap by unscrewing the stainless steel collar.
- Lift up on the top of the sensor housing and set it to the side.
- Inspect O-ring for cracking, replace if necessary. Always lube your O-rings!
- Remove the sensor from its box. With scissors, open nitrogen purged packaging and remove the sensor.
- Visually inspect sensor for damage, if damaged notify the factory immediately.
- Remove the shorting tab across the back of the sensor circuit board (red tape).
- Place the sensor inside the housing with the metal mesh screen facing down and the circuit board contacts facing up.
- Return upper portion of the sensor housing to the stainless steel bottom. Tighten collar. Hand tight is acceptable to create an airtight seal.
- Immediately start purge of zero gas.
- If the analyzer has not been calibrated, refer to section 4.1 for more information.

**** Sensor should not be exposed to ambient air for more than 2 minutes. Extended periods of exposure can damage the low end sensitivity and response time.**

Temperature Rating of Oxygen Sensor Models:

TO2-133:	0 to 50 deg C
TO2-233:	-20 to 50 deg C
TO2-238:	-20 to 50 deg C
PO2-160:	0 to 50 deg C
PO2-24:	-20 to 50 deg C

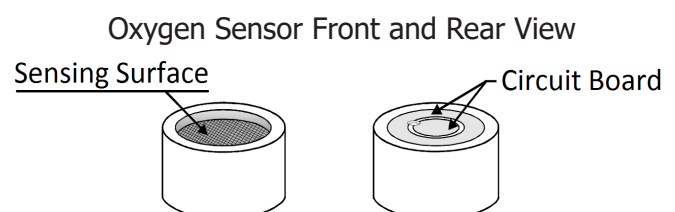

2.6 Integral Sample System Flow Diagram

Southland Sensing Ltd. strives to select the highest quality sample system components in the market. All gas connections are made via compression tube fittings. Our valves are high quality leak tight which we rigorously test in our environmental chamber. Our flow indicators / flow meters are sourced from an industry recognized leader in flow control. When dealing with critical applications such as petrochemical processing and natural gas extraction, we want to make sure we can deliver a high quality sample system and we do so by partnering with some of the best brands in the market.

Along with our standard sample system as shown below, we can also custom design sample systems to meet unique applications including the additional of moisture filters, pressure regulators, H₂S scrubbers, etc. For more information on a custom solution for your application, please contact your local distributor or the factor.

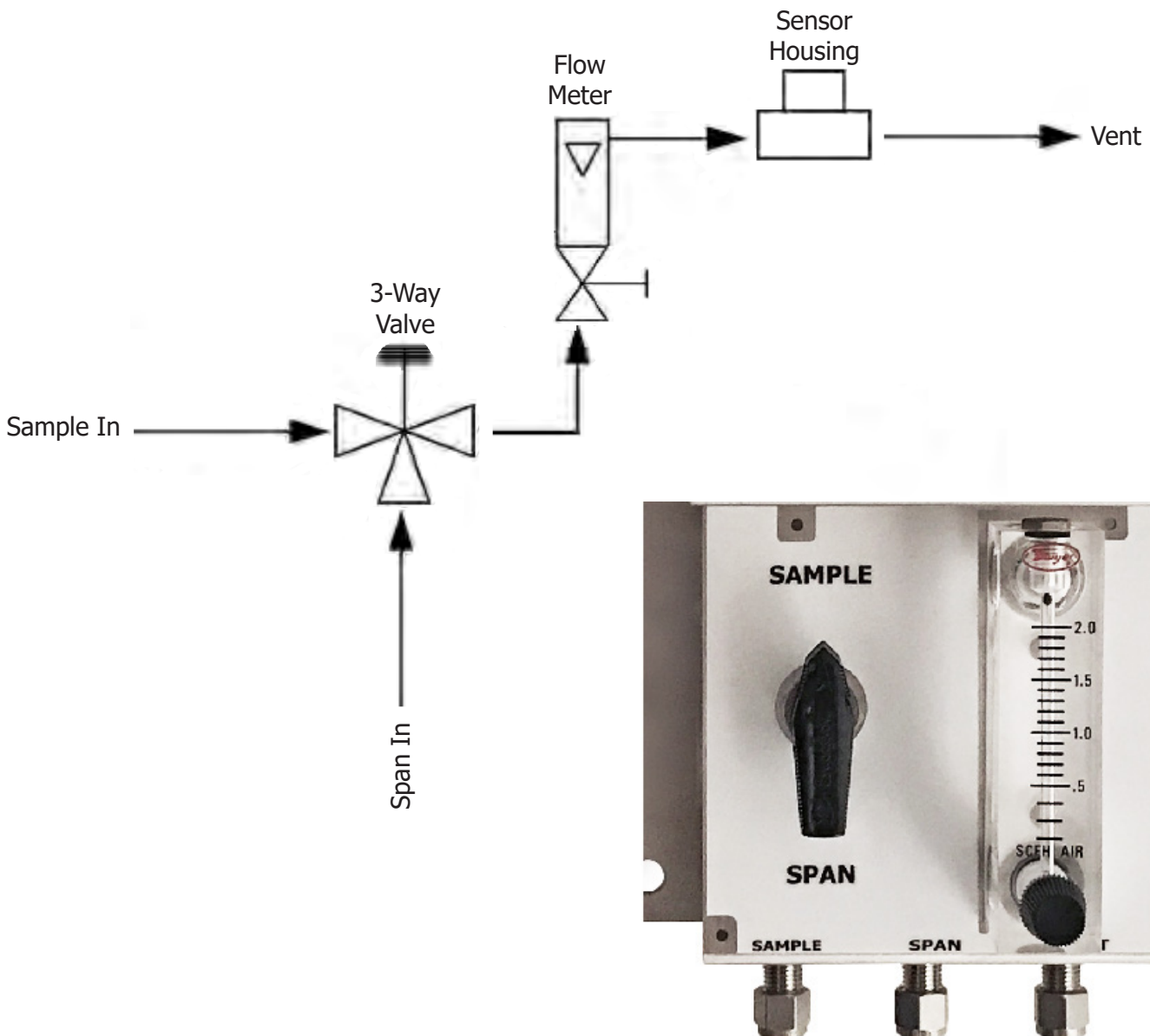

3.1 Understanding the Controls and their Operation

The OMD-625 Oxygen Analyzer is a feature packed unit with an easy-to-use menu interface. The key attributes within the menu are the ability to select a measurement range manually or using the auto-range mode, to calibrate the unit with a known gas, also referred to as a SPAN Calibration or SPAN CAL, and to perform a zero calibration (if necessary, for most applications it is not required).

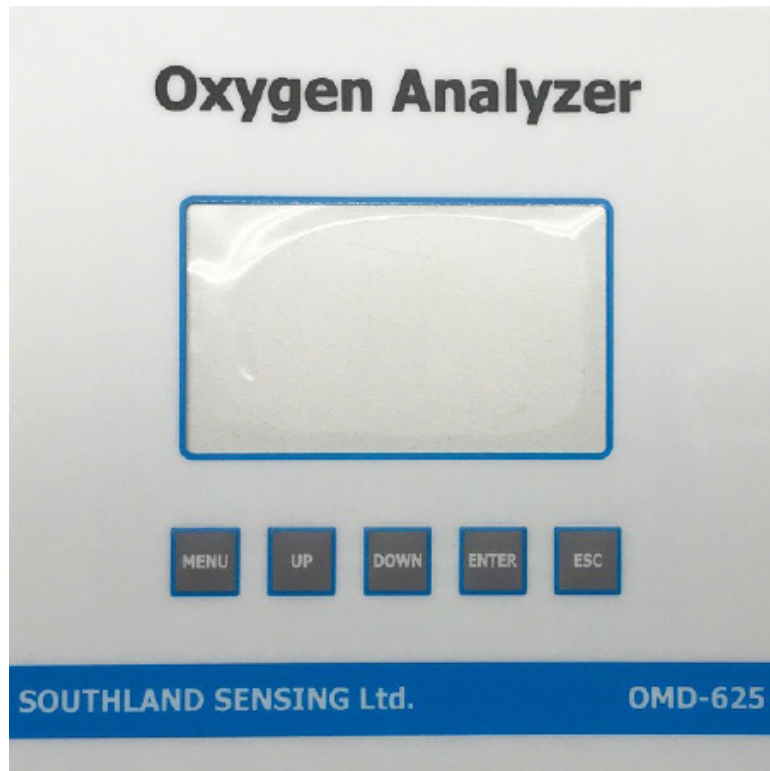

All features are programmable / selectable through the MENU button. The UP / DOWN buttons will allow you to select your set points and the ENTER button saves the data. If you want to cancel your selection, or return to the previous screen the escape key ESC will allow you to do this. Once the unit starts up, the following home screen will appear:

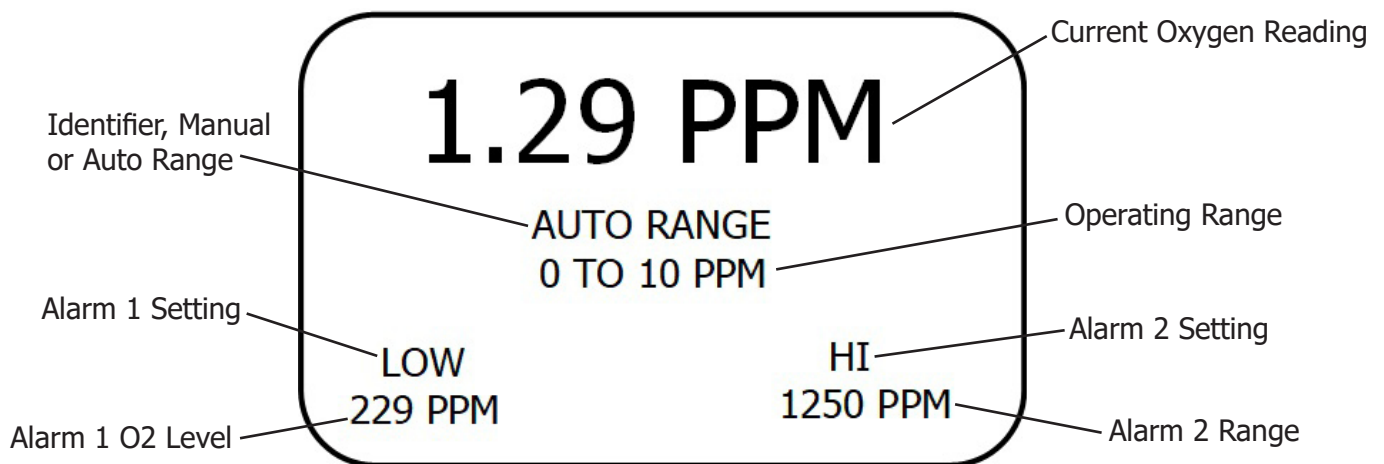

3.2 Measurement Range Overview

The OMD-625 oxygen analyzer allows the user to field select 5 available ranges - custom ranges can be programmed in the built-in menu, see Section 3.5. These ranges can be selected in manual mode, meaning they are locked into that range by the user, or they can be set to auto-range so the analyzer will adjust to give you the best full scale resolution.

When using the Manual-Range mode the Manual Range locks the 4 - 20mA output to a single range, and the display will continue to operate in auto-range mode giving the user the full spectrum of analysis ranges. Other manufactures lock the display as well - the problem is if you over-range and the display is locked you have no idea what your oxygen value is. The OMD-625 solves this issue with a display that auto-ranges and the ability to manually lock the analog outputs.

To select Auto-Range or Manual-Range Mode, from the HOME screen, press the MENU key and the display will indicate:

Using the UP / DOWN keys to change which option is highlighted will allow the user to select AUTO-RANGE, which will allow the unit to cycle through all five ranges, or MANUAL RANGE which will allow the user to select a specific range.

Decide which option will work best for your application. Highlight the selection and press the ENTER key. If you have selected the AUTO RANGE option, it will blink for a second indicating this was selected. If you selected the MANUAL RANGE option, the following screen will be brought up:

****Note: Analyzers can be configured for Trace, Percent and Purity Analysis so your ranges might be different.**

**Trace: 0 - 10ppm, 0 - 100ppm, 0 - 1000ppm, 0 - 10000ppm, 0 - 25%
Percent: 0 - 1%, 0 - 5%, 0 - 10%, 0 - 25%, 0 - 100%
If a custom range has been set, it will appear below the 0 - 10 ppm range.**

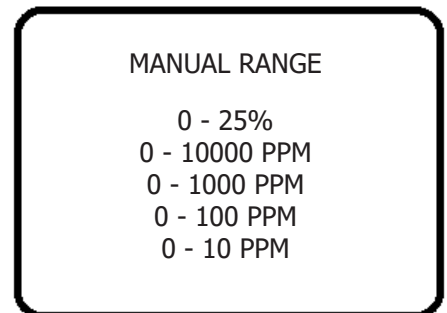
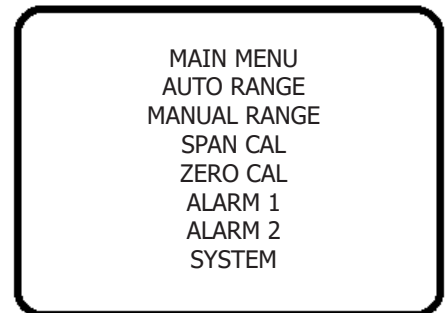

Use the UP / DOWN keys to highlight the range to be selected and press the ENTER key. The selected range will blink for a second indicating the range has been selected.

Press the ESC key to move back to the previous screen.

3.3 Analog Output

**** Caution: Integral 4 - 20mA converters are internally powered and do not require external power. DO NOT supply any voltage across these terminals as the 4 - 20mA output will be damaged. It is also important to assure proper grounding of the external recording device such as a PLC, DCS prior to connecting the 4 - 20mA.**

The OMD-625 is equipped with a 4 - 20mA analog output. When physically connecting the analog output, refer to the circuit board pinout in section 2.3

To verify the signal output of the 4 - 20mA circuit is working properly, connect an ammeter across the (+) and (-) pins. With no oxygen sensor connected, it should read approximately 4 mA. If a sensor is installed you can verify the signal matches with the following formula:

$$\text{Signal Output (mA)} = [(\text{Reading} / \text{Full Scale Range}) \times 16] + 4$$

For example, if we are reading 500ppm on the 1000 ppm range:

$$\text{Signal Output (mA)} = [(500/1000) \times 16] + 4$$

$$\text{Signal Output (mA)} = 12\text{mA}$$

Some PLC's prefer a 1 - 5V DC analog output. The output can be configured for either 4-20 mA or 1-5 VDC using the built-in menu. Enter the MENU and select SYSTEM, select OUTPUT TYPE and it will allow you to select either analog output (4 - 20mA or 1 - 5V DC).

3.4 Advanced Integral Alarms

The OMD-625 Oxygen Analyzer is equipped with 2 advanced relay contact alarms. These alarms can be configured as normally open or normally closed, have a delay mode built-in, and can be enabled or disabled when necessary.

The alarms are rated at 5A @ 230VAC. If you are connecting to solenoid valves or a pump whose current can fluctuate greatly, it is advisable to use a slave relay to ensure no damage occurs to the electronics.

The procedure for setting Alarm 1 and Alarm 2 is identical. To begin, highlight the alarm configuration you want to adjust using the UP / DOWN keys in the analyzer MENU and press ENTER.

To adjust the value setpoint of ALARM 1 simply highlight ALARM 1 and press ENTER. Select the ADJUST ALARM option, where you will be able to adjust the levels using the UP / DOWN buttons. To set a PPM level alarm simply hold the DOWN button until you get below 1%. To set the alarm press ENTER.

The alarm function allows the user to set the alarm to trigger the relay contacts as a HIGH alarm or a LOW alarm. Simply open the ALARM 1 menu and UP or DOWN to meet your requirements.

The alarm has a built in DELAY TIME. This is ideal to use when you are working on your process and do not want to have the alarm relay contacts trip. You will set this in a similar fashion to setting the alarm. The DELAY TIME is in minutes, so adjust the value accordingly.

The alarm can also be enabled / disabled should it be hooked up but not required. Highlight ALARM ON/OFF using the UP / Down keys to and press the ENTER key.

The alarms can function as normally open or normally closed. This selection will be chosen when hooking up the wiring, it is not completed through the software. See the wiring diagram in section 2.4 for more information.

If you any questions about the ALARM functions should arise, please contact the factory for assistance or technical questions.

```
MAIN MENU
AUTO RANGE
MANUAL RANGE
SPAN CAL
ZERO CAL
ALARM 1
ALARM 2
SYSTEM
```

```
ALARM 1 MENU

ALARM ON/OFF
ALARM TYPE
ADJUST ALARM
DELAY MODE
```

3.5 Setting a Custom Range

The OMD-625 Oxygen Analyzer can have a custom range programmed into it in case you need a specific non-standard range. Once you have set your custom range, you can select it in the Manual Range menu to lock the 4-20 mA output to that range.

To set a custom range, perform the following steps:

Press the MENU button to go into the onboard menu. Use the UP/DOWN buttons to scroll down to SYSTEM and press the ENTER button.

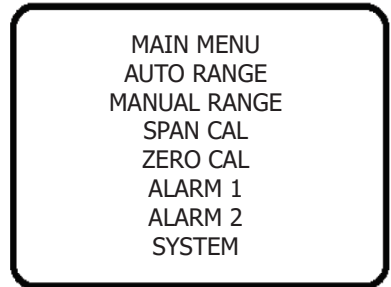

Scroll down to highlight CUSTOM RANGE and press ENTER.

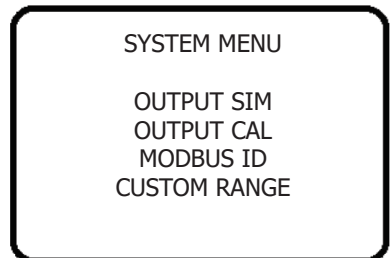

The value shown will be the upper value of the range, in this case the custom range is going to be 0-995 PPM. Use the UP button to increase the value, and the DOWN button to decrease it. Press ENTER to lock in the value, or ESC to return to the menu.

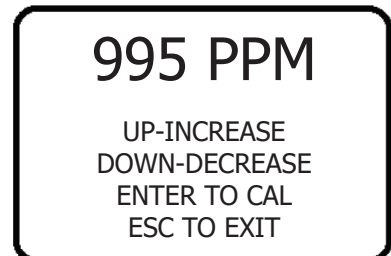

3.6 Output Simulation

Caution: Integral 4 - 20mA converters are internally powered and do not require external power. DO NOT supply any voltage across these terminals as the 4 - 20mA output will be damaged. It is also important to assure proper grounding of the external recording device such as a PLC, DCS prior to connecting the 4 - 20mA.

The OMD-625 allows the user to simulate an analog output to calibrate a PLC or DCS system. To accomplish this, the OMD-625 will self generate a 4mA, 8mA, 12mA, 16mA or 20mA signal output. Important note, this output simulation can be done with the oxygen sensor installed and purging on gas.

To simulate the output, the user will want to enter the MENU and select SYSTEM. From here, the user can select OUTPUT SIM which will then give them the option of what mA signal they wish to use. Move the cursor UP or DOWN to the mA desired and the analog output of the unit will adjust. For example, if you move the cursor to the 12mA, the output will change to 12mA. Once calibration of the PLC or DCS system is complete, hit ENTER or ESC to return to the HOME screen.

3.7 Output Calibration

The OMD-625 is equipped with a protocol to adjust the 4mA and 20mA signal output to account for signal degradation over long copper wires. This might occur in the field if you have 100 feet or more of cable between your OMD-625 and control panel.

To adjust the analog output, hook an ammeter or PLC up to the 4 - 20mA output. Enter the MENU screen and go to SYSTEM. From here, enter the OUTPUT CAL and it will prompt you to adjust the 4mA output. Press the UP or DOWN button to adjust, keep pressing the button if you need additional adjustment. Ignore the number on the display as this is an internal calculation, the ammeter or PLC system would be the appropriate way to verify, once it is reading 4mA hit ENTER. Once complete it will prompt you to do the same adjustment for the 20mA.

An important note, the sensor can be installed for this adjustment and does not need to be removed as is the case with competitive equipment. The electronics isolate out the sensor and allow for a nearly perfect 4mA and 20mA scale adjustment.

If the user prefers to calibrate the PLC by simulating a current such as 4mA, 8mA, 12mA, 16mA or 20mA, please refer to section 3.6.

4.1 Span Calibration using Ambient Air

Calibration involves using a known span gas to match and adjust the oxygen sensor / analyzer combo to a known value. This can be as simple as using ambient air, which tends to be a constant 20.9%, which is what we will focus on for section 4.1. For calibrating with a certified SPAN Gas, please proceed to section 4.2. For a recommendation on which type of calibration is best for your process consult the factory.

Calibration using Ambient Air:

If using ambient air to calibrate the sensor, it is recommended to read through the calibration procedure prior to performing an air calibration to make sure all instructions are understood. Consult the factory if any questions arise.

If the sensor is already installed in the sensor housing, you will need to connect the gas sample line as noted in section 2.4 or expose the sensor to ambient air which is typically 20.9%. With the flow through sensor housing you can open up the housing and with two fingers hold the sensor to the top portion of the housing, making sure the sensor contacts are firmly touching the gold pogo pins in the housing. Make sure the sensor screen of the oxygen sensor is facing the ground for optimum results.

Let the reading stabilize for about 30 - 45 seconds and then proceed to the following steps in the OMD-625 menu:

SPAN CALIBRATION: To calibrate the transmitter, press the MENU key then use the UP/DOWN keys to highlight the SPAN CAL option and press the ENTER key.

Use the UP / DOWN keys to adjust the reading on the display until it matches the value of your SPAN Gas. For example if your SPAN gas is 20.9% adjust the display UP or DOWN until it reads 20.9%.

Press the ENTER key and the display will show "PASSED" or "FAILED." If passed, promptly put the sensor in a zero or low oxygen gas. This will help extend the life of the sensor and speed of response. If failed, repeat calibration steps or consult the factory.

Trace Oxygen Sensor Caution: The sensor should not be exposed to ambient air for more than 2 minutes. This will help speed of response, sensor life, and low end sensitivity.

MAIN MENU
AUTO RANGE
MANUAL RANGE
SPAN CAL
ZERO CAL
ALARM 1
ALARM 2
SYSTEM

20.9%

UP TO INCREASE
DOWN TO DECREASE
ENTER TO CAL
ESC TO EXIT

4.2 Span Calibration using a Certified Span Gas

Calibration involves using a known span gas to match and adjust the oxygen sensor / analyzer combo to a known value. This can be as simple as using ambient air that tends to be a constant 20.9% or a bottle of certified span gas from your local air separation company. For this section, we will focus on using a certified span gas from your local air separation company. When using a certified bottle, it is recommended to get a span gas equal to 90% or higher of the range you want to use. If you are measuring in the 0 - 1000 ppm range, a 900 ppm nitrogen with a balance of oxygen would be ideal.

For a recommendation on which type of calibration is best for your process consult the factory.

Calibration using Certified Span Gas:

It is recommended to read through the calibration prior to performing an air calibration to ensure all instructions are understood. Consult the factory if any questions arise.

Note: For a new trace oxygen sensor (TO2-133, TO2-233 or TO2-238), purging with a zero gas for 4 - 6 hours will help the low end stability and response. This is not necessary on a percent or purity sensor.

Connect the gas span line and set the pressure / flow per section 2.4 of the users manual.

Once the gas is flowing, let the reading stabilize for about 5 - 10 minutes and then proceed (consider longer if sensor is still trending down, very important when trying to calibrate with a low span gas such as 5 ppm o₂ / balance nitrogen).

SPAN CALIBRATION: To calibrate the indicator, press the MENU key and use the UP/DOWN keys to highlight the SPAN CAL option and press the ENTER key.

Use the UP / DOWN key until the reading on the display matches the value of your SPAN gas. For example, if your SPAN gas is 8.09 ppm adjust the display UP or DOWN until it reads 8.09 ppm.

Press the ENTER key and the display will show "PASSED" or "FAILED." If passed, promptly put the sensor in a zero or low oxygen gas. This will help extend the life of the sensor and speed of response. If failed, repeat calibration steps or consult the factory.



MAIN MENU
AUTO RANGE
MANUAL RANGE
SPAN CAL
ZERO CAL
ALARM 1
ALARM 2
SYSTEM



8.09

PARTS PER MILLION
UP TO INCREASE
DOWN TO DECREASE
ENTER TO CAL
ESC TO EXIT

Trace Oxygen Sensor Caution: The sensor should not be exposed to ambient air for more than 2 minutes. This will help speed of response, sensor life, and low end sensitivity.

4.3 Procedure for Replacing the Oxygen Sensor

The characteristics of a precision electrochemical fuel cell are similar to those of a battery. They both provide an output that is nearly constant throughout their useful life and simply fall off sharply towards zero at the end.

If the process sample that is being analyzed is in the low range (0 - 10 ppm) of oxygen concentration, cell failure will be indicated by the inability to properly calibrate the analyzer. The user will also find that very little adjustment of the span calibration feature will be necessary to keep the analyzer in calibration during the sensors useful life. If a large adjustment is needed to calibrate the unit, or calibration cannot be reached, the sensor should immediately be replaced.

**** Note, make sure to read section 2.5 "Installing the Oxygen Sensor" before replacing the sensor.**

No tools are required to replace the sensor. Open the front of the analyzer then simply unscrew (counter-clockwise) the collar on the housing inside. Once free, open the top portion of the sensor housing exposing the old oxygen sensor. Remove the old oxygen sensor, disposing of it like you would a lead-acid battery in accordance with your local regulations.

Remove the new sensor from its package and remove the red shorting strip. Place the sensor screen side down in the sensor housing with the copper circuit board pointed up. Proceed to re-connect the collar.

After the sensor has been replaced, proceed to the Span Calibration section and purge with inert gas.

**** Trace oxygen sensors should not be exposed to ambient air for more than a few minutes or their response time and expected life will be adversely affected.**

4.4 Troubleshooting

For troubleshooting and advanced maintenance techniques, please contact your factory representative for assistance.

Email: sales@sso2.com
Ph: 1-949-398-2879

4.5 Zero Calibration

In theory, the oxygen sensor is linear over its measurement range and has no signal output when exposed to an oxygen free environment. However, in reality expect the analyzer to generate a small signal in an oxygen free environment due to one or more of the following:

Minor leakage in the sample gas connections, contamination or quality of zero gas, small amounts of dissolved oxygen in the sensor electrolyte, or tolerance of electronic components in the analyzer.

When is a ZERO Calibration Recommended:

A zero calibration is recommended for online and portable oxygen analyzers in applications where a continuous and precise measurement of oxygen is required below 4.5% of the lowest 2 ranges (i.e. when measuring 0.45 ppm or below on the 0 - 10ppm range and 4.5 ppm or below on the 0 - 100ppm range). A zero calibration is only recommended when these conditions are met and when the user is installing a new oxygen sensor.

For most applications a ZERO calibration is not necessary, if you are unsure if a ZERO calibration is required for your installation, contact the factory and consult with our application specialists for a recommendation.

CAUTION: Prematurely zeroing the analyzer can cause erroneously low readings and extra caution should be taken to make sure a zero calibration is performed accurately.

Determining the zero point is met: the user should allow the analyzer to be purged on zero gas for approximately 24 hours to stabilize the flowing gas. There should be no downward trend of the reading.

Zero Calibration Procedure:

Zero Calibration should precede the span calibration and once performed should not have to be repeated with subsequent span calibrations. The zero calibration should only be performed once, as well as when a new sensor is installed or if changes are made to the sample system connections.

The maximum zero calibration adjustment permitted is 45% of the lowest full scale range availability (roughly 4.5ppm). As such, the analyzer ZERO has not been performed at the factory prior to shipment as the factory gas connections and application conditions are different than the user's installation.

Allow the analyzer to be purged with a zero gas for 24 hours and verify that the oxygen reading is not trending. Once the reading stabilizes and is below 4.5 ppm, proceed to the menu to perform a zero calibration:

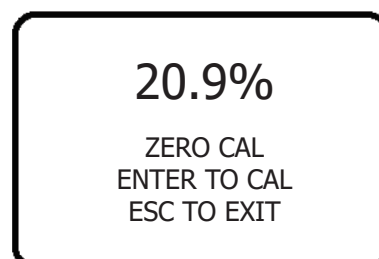
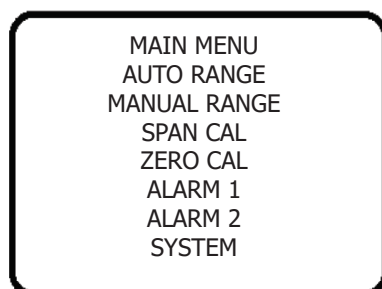

Once the ZERO Calibration procedure is complete, the display will show "PASSED" or "FAILED." If Failed, your reading was most likely above the 4.5ppm threshold or the 24 hour purge on zero gas was not complete. Check your connections and zero gas and verify the unit is stable and not still trending down. Contact the factory for additional troubleshooting techniques.

5.1 Spare Parts List

Spare Parts List - OMD-625

Replacement Oxygen Sensors:

T02-133	PPM Oxygen Sensor (inert gas)
T02-233	PPM Oxygen Sensor (CO2 background gas)
PO2-160	Percent Oxygen Sensor (inert gas)
PO2-24	Percent Oxygen Sensor (CO2 background gas)
T02-238	H2S Resistant PPM Oxygen Sensor

Replacement Parts:

EX-PCB-10047-1	Circuit Board for OMD-625 Gen 2
EX-PCB-10041-2	Power Board, DC OMD-625 Gen 2 (4-Wire DC)
EX-PCB-10041-3	Power Board, DC OMD-625 Gen 2 (4-Wire DC + Modbus)
EX-PCB-10041-4	Power Board, DC OMD-625 Gen 2 (100 - 240VAC)
EX-PCB-10041-5	Power Board, DC OMD-625 Gen 2 (100 - 240VAC + Modbus)
EX-PCB-10049	MODBUS RTU RS485 Add On Board (Optional)
ORING-1001	Sensor Housing O'ring
FUSE-1001	Replacement Fuse OMD-625

For additional troubleshooting or replacement parts, please contact the factory:
sales@sso2.com; Ph: 1-949-398-2879

5.2 Warranty

Oxygen Analyzer / Sensor Warranty

The design and manufacture of our analyzers and precision electrochemical oxygen sensors conforms to established standards and incorporates state of the art materials and components for superior performance while still maintaining minimal cost of ownership. Prior to shipment, every analyzer / sensor is thoroughly tested by the manufacturer. When operated and maintained in accordance with the Owner's Manual, the units will provide many months of reliable service.

Coverage

Under normal operating conditions the analyzers / sensors are warranted to be free of defects in materials and workmanship for the period specified in accordance with the most recent published specifications, said period begins with the date of shipment by the manufacturer. The manufacturer information and serial number of this analyzer / sensor are located visibly on the unit. Southland Sensing Ltd. reserves the right in its sole discretion to invalidate this warranty if the serial number does not appear.

Limitations

Southland Sensing Ltd. will not pay for: loss of time, inconvenience, loss of use, or property damage caused by the oxygen analyzer / sensor or its failure to work.

Exclusions

This warranty does not cover installation, defects resulting from accidents, damage while in transit to our service location, damage resulting from alterations, misuse or abuse, lack of proper maintenance, unauthorized repair or modification of the analyzer, affixing of any label or attachment not provided with the analyzer, fire or flood.

Service

Call Southland Sensing Ltd. at 1-949-398-2879 (or e-mail sales@sso2.com). Trained technicians will assist you in diagnosing the problem.

5.3 Material Safety Data Sheet (MSDS)**Product Identification**

Product Name	Oxygen Sensor Series – PO ₂ , TO ₂ series
Synonyms	Precision Electrochemical Sensor
Manufacturer	Southland Sensing Ltd, 4045 E. Guasti Rd. Suite 203 Ontario, CA 91761
Emergency Phone Number	1-949-398-2879
Preparation / Revision Date	April 23rd, 2016
Notes	Oxygen sensors are sealed, contain protective coverings and in normal conditions do not present a health hazard. Information applies to electrolyte unless otherwise noted.

Specific Generic Ingredients

Carcinogens at levels > 0.1%	None
Others at levels > 1.0%	Potassium Hydroxide or Acetic Acid, Lead
CAS Number	Potassium Hydroxide = KOH 1310-58-3 or Acetic Acid = 64-19-7, Lead = Pb 7439-92-1

General Requirements

Use	Potassium Hydroxide or Acetic Acid - electrolyte, Lead - anode
Handling	Rubber or latex gloves, safety glasses
Storage	Indefinitely

Physical Properties

Boiling Point Range	KOH = 100 to 115 C or Acetic Acid = 100 to 117 C
Melting Point Range	KOH -10 to 0 C or Acetic Acid – NA, Lead 327 C
Freezing Point	KOH = -40 to -10 C or Acetic Acid = -40 to -10 C
Molecular Weight	KOH = 56 or Acetic Acid – NA, Lead = 207
Specific Gravity	KOH = 1.09 @ 20 C, Acetic Acid = 1.05 @ 20 C
Vapor Pressure	KOH = NA or Acetic Acid = 11.4 @ 20 C
Vapor Density	KOH – NA or Acetic Acid = 2.07
pH	KOH > 14 or Acetic Acid = 2-3
Solubility in H ₂ O	Complete
% Volatiles by Volume	None
Evaporation Rate	Similar to water
Appearance and Odor	Aqueous solutions: KOH = Colorless, odorless or Acetic Acid = Colorless, vinegar-like odor

Fire and Explosion Data

Flash and Fire Points	Not applicable
Flammable Limits	Not flammable
Extinguishing Method	Not applicable
Special Fire Fighting Procedures	Not applicable
Unusual Fire and Explosion Hazards	Not applicable

5.3 Cont. Material Safety Data Sheet (MSDS)**Reactivity Data**

Stability	Stable
Conditions Contributing to Instability	None
Incompatibility	KOH = Avoid contact with strong acids or Acetic Acid = Avoid contact with strong bases
Hazardous Decomposition Products	KOH = None or Acetic Acid = Emits toxic fumes when heated
Conditions to Avoid	KOH = None or Acetic Acid = Heat

Spill or leak

Steps if material is released	Sensor is packaged in a sealed plastic bag, check the sensor inside for electrolyte leakage. If the sensor leaks inside the plastic bag or inside an analyzer sensor housing do not remove it without rubber or latex gloves and safety glasses and a source of water. Flush or wipe all surfaces repeatedly with water or wet paper towel (fresh each time). Disposal In accordance with federal, state and local regulations.
-------------------------------	---

Health Hazard Information

Primary Route(s) of Entry	Ingestion, eye and skin contact
Exposure Limits	Potassium Hydroxide - ACGIH TLV 2 mg/cubic meter or Acetic Acid - ACGIH TLV / OSHA PEL 10 ppm (TWA), Lead - OSHA PEL .05 mg/cubic meter
Ingestion	Electrolyte could be harmful or fatal if swallowed. KOH = Oral LD50 (RAT) = 2433 mg/kg or Acetic Acid = Oral LD50 (RAT) = 6620 mg/kg
Eye	Electrolyte is corrosive and eye contact could result in permanent loss of vision.
Skin	Electrolyte is corrosive and skin contact could result in a chemical burn.
Inhalation	Liquid inhalation is unlikely.
Symptoms	Eye contact - burning sensation. Skin contact - soapy slick feeling.
Medical Conditions Aggravated	None
Carcinogenic Reference Data	KOH and Acetic Acid = NTP Annual Report on Carcinogens - not listed; LARC Monographs - not listed; OSHA - not listed
Other	Lead is listed as a chemical known to the State of California to cause birth defects or other reproductive harm.

Special Protection

Ventilation Requirements	None
Eye	Safety glasses
Hand	Rubber or latex gloves
Respirator Type	Not applicable
Other Special Protection	None

Special Precautions

Precautions	Do not remove the sensor's protective Teflon and PCB coverings. Do not probe the sensor with sharp objects. Wash hands thoroughly after handling. Avoid contact with eyes, skin and clothing. Empty sensor body may contain hazardous residue.
Transportation	Not applicable

5.4 Certificate of Conformance

Model Number: OMD-625 Oxygen Analyzer
Serial Number: _____

Sensor Selection: TO2-133 Trace Oxygen Sensor
 TO2-233 Trace Oxygen Sensor CO2 > 0.1%
 TO2-238 H2S Resistant PPM Oxygen Sensor
 PO2-160 Percent Oxygen Sensor
 PO2-24 Percent Oxygen Sensor CO2 > 0.1%

Serial Number: _____

Sensor Housing Selection: H3 Flow Through Sensor Housing

Sample System: Sample / Span valve, Flow Meter, 1/4" Compression Tube Fittings
 Sample / Span valve, Flow Meter, 1/8" Compression Tube Fittings
 Sample / Span valve, Flow Meter, 6mm Compression Tube Fittings
 Delete Sample System; Fittings: _____

Configuration:
Ranges: 0 - 10ppm, 0 - 100ppm, 0 - 1000ppm, 0 - 10000ppm, 0 - 25%
 0 - 1%, 0 - 5%, 0 - 10%, 0 - 25%, 0 - 100%
Power: 12 - 24 V DC 4-Wire
 12 - 24 V DC 4-Wire + Bi-directional MODBUS RS485 RTU
 100 - 240 V AC
 100 - 240 V AC + Bi-directional MODBUS RS485 RTU

Analog Output: 1 - 5 V DC Range ID Output
 4 - 20 mA DC Range ID Output

Display: Backlight

We certify that the parts shipped to you are manufactured in the USA and conform to all requirements of the Purchase Order. These parts have been manufactured and tested to the highest quality standards and in accordance with all required specifications, instructions and technical drawings.

Date: _____

Signature: _____

5.5 MODBUS RS485 RTU Bi-Directional Communication Protocol

MODBUS RTU Protocol

The OMD-625 uses MODBUS RTU at 19200 Baud, 8 bits of data, 1 stop bit, and Even Parity. The communication settings are not adjustable on the OMD-625. The MODBUS ID number is set as 1.

MODBUS RTU structure looks like this:

DEVICE ADDRESS 1 char ID = 1
 FUNCTION CODE 2 chars
 REGISTER NUMBER 2 chars
 REGISTER COUNT n chars Data + length, depends on message length
 DATA n chars, depends on message length
 CRC CHECKSUM 4 chars , Hi and Lo Error

The MODBUS RTU Checksum is CRC16.

The OMD-625 will respond to MODBUS commands 4, 6, and 16.

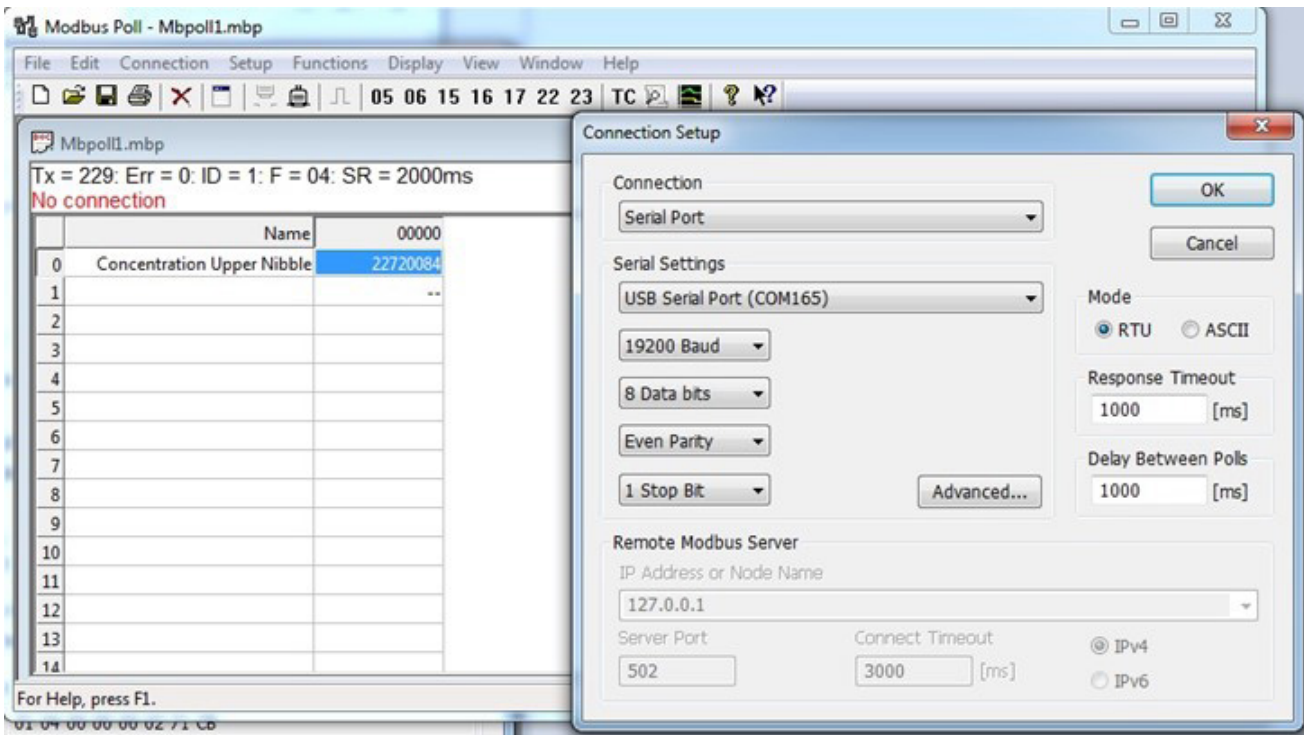

5.5_2 MODBUS RS485 RTU Bi-Directional Communication Protocol

MODBUS RTU Protocol

Gas concentration when read from or when written to the OMD-625 is in PPM, as XX XX XX.XX, ie. 22.7 Percent Oxygen on the display would be 227,194.82 and would appear as 22719482.

Command 4 is for reading input registers, we use this when reading gas concentration. This will return the gas concentration in PPM, regardless of the manual range setting. The MODBUS command to read input registers is as follows, “:01 04 00 00 00 02 71 CB”.

- “01” Device ID,
- “04” Function – Read Input Registers, “00” 1st Register High Byte,
- “00” 1st Register Low Byte,
- “00” Number of Registers Hi Byte, “02” Number of Registers Low Byte,
- “71” Error Check Lo
- “CB” Error Check Hi

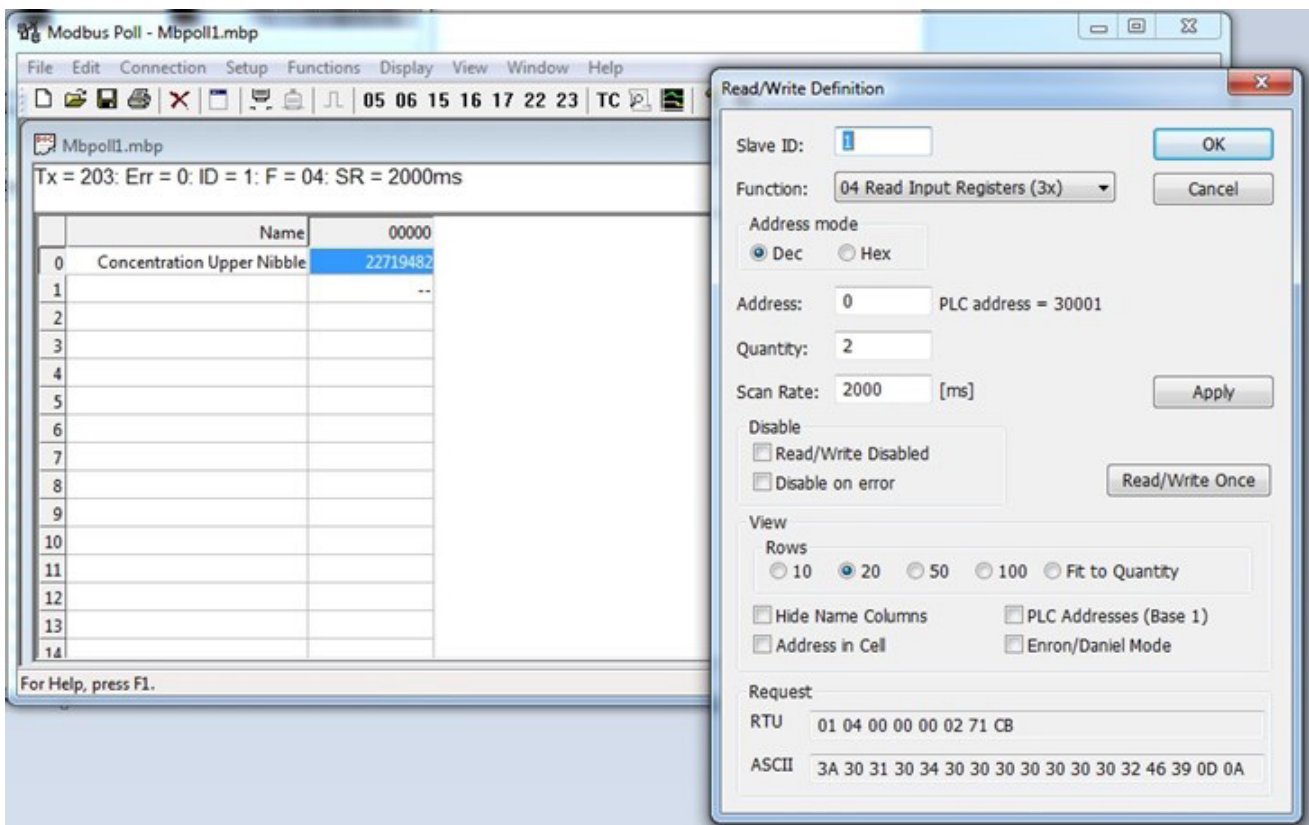

5.5_3 MODBUS RS485 RTU Bi-Directional Communication Protocol

MODBUS RTU Protocol

Command 4 will return the gas concentration, the following example is for MODBUS ID #1, and is returning 22.7 Percent or 227,194.82 PPM, " 01 04 04 01 5A A5 A6 21 41 ". In this instance 01 5A A5 A6 Hex = 22717862 Decimal, or 227,194.82 PPM

- "01" Device ID,
- "04" Function – Read Input Registers,
- "04" Byte Count – Always 4 bytes
- "01", Data Byte Hi, #1
- "5A", Data Byte Lo, #1
- "A5", Data Byte Hi, #2
- "A6", Data Byte Lo, #2
- "21", Error Check Lo
- "41", Error Check Hi

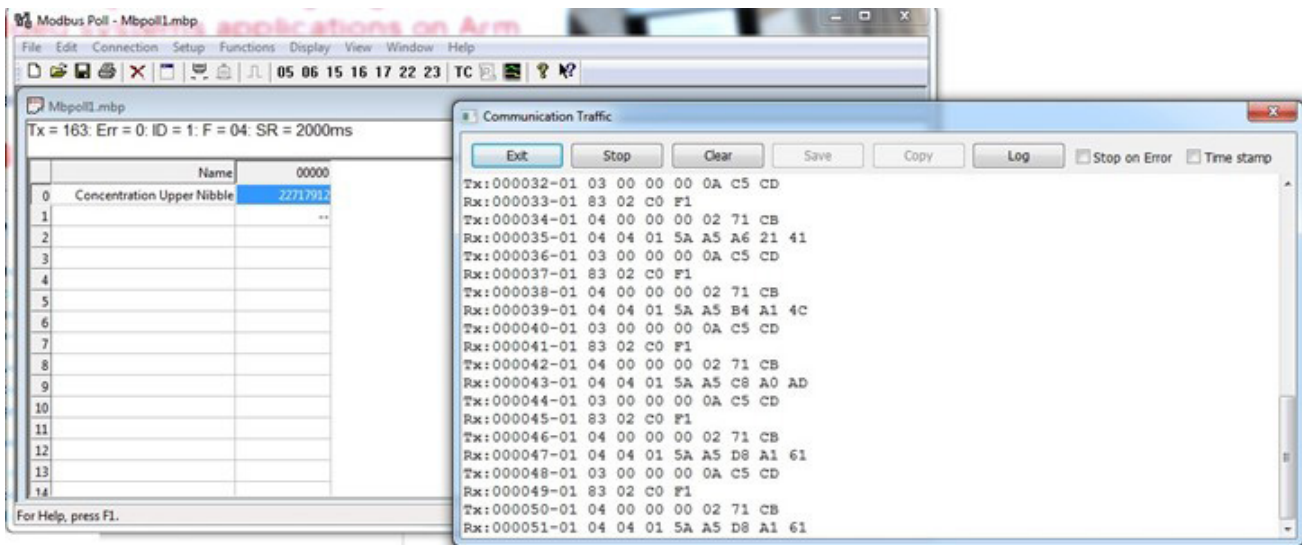

5.6 Explosion Proof Electrical Connections

Electrical connections require an approved explosion proof cable gland / conduit sealing fitting and packing around wires and cables (for incoming power for the analyzer electronics and analyzer outputs) coming into and out of the explosion proof enclosure that houses the power supply.

Full compliance with hazardous area electrical code requires the user to supply cable gland, fittings and /or conduit commensurate with the level of protection or classification desired. To maintain the ATEX / IECEx / UKEX certification of this unit, the user must install ATEX / IECEx / UKEX approved components according to the published directives.

Additional Specific Requirements:

- 1.) Only cable glands and conduit sealing fittings certified for protection type 'd' and have an IP66 rating may be used.
- 2.) All unused device openings must be fitted with a certified close-up plug with protection types 'd' and have an IP66 rating may be used.
- 3.) Only one Hazardous Location Solutions reducer shall be used with any single cable entry on the associated equipment.
- 4.) The cable specific minimum ambient temperature is marked on the line bushing and it is detailed in the shipping documents.
- 5.) Stopping plugs are not to be used in conjunction with any other cable entry device.

To fill an open hole, if the user needs to install any blanking element / glands themselves, the user will need to source a 1/2 inch NPT element.

Note: The following instruction is supplied from information and data supplied by a reputable gland manufacturer which we believe is reliable and is given in good faith. Since the methods of application and conditions under which our products are put to use are beyond our control, we are not able to guarantee the application and/or use of same. The user assumes all risks and liability in connection with the application and use of our products.

Instruction Guide: All products should be installed in accordance with all relevant Installation Standards and Codes of Practice e.g. EN/IEC 60079-14, NEC/CEC.

- Installation should only be carried out by a suitably trained person.
- Under no circumstances should installation be carried out under live conditions.
- The installer should ensure that no damage occurs to any thread or form of seal during installation. Where component is plated care should be taken to prevent damage or chipping.
- Element (1/2 inch NPT in size) should be installed hand tight and then tightened a further 1 to 2 full turns, wrench tight or tool secure.
- Ensure that the torque values are applied and do not exceed the maximum torque that can be applied to the enclosure to achieve IP ratings.

5.7 Potential Electrostatic Charging Hazard

Static electricity is the electrical charge produced on two dissimilar materials through physical contact and separation caused by the imbalance of positive and negative charges between the two.

As an electrostatic charge accumulates, the electric fields and voltages increase. If the charge is unable to bleed off to ground when the electric field exceeds the insulating properties of the atmosphere, a static discharge hazard can occur.

For the 625 series analyzer, depending on the environmental conditions, there is a risk of this occurring between the stainless steel metal box and the polyester membrane keypad. It is recommended to not touch the buttons unless you have ensured there is a low potential difference between the user and the surface being touched, or the user should use an insulating medium to touch the surface. Additionally the equipment should be installed in an area where electrostatic charge is not likely to form, such as away from direct airflow, etc.

In some installation environments the user can apply a conductive coating to the overlay to reduce the risk of an electrostatic charging hazard. The user would need to decide the acceptable durability of the coating material with respect to the environmental conditions.